

MEC

MEDICAL LIMITED

PRODUCT CATALOGUE
AND PRICE LIST **2020**



- Hose Assemblies
- Ambulance Pipeline Equipment
- Change-over valves
- Terminal Units
- Flowmeters
- Pipeline Suction
- Electric Suction
- Regulators
- Pipeline Accessories
- Medical Gas Plant
- Medical Gas Test Equipment
- Anaesthesia and Gas Scavenging Systems (AGSS)



MEC are a leading manufacturer and worldwide supplier of Medical Gas Equipment for, Hose Assemblies, Oxygen Therapy Equipment, Medical Gas Test Equipment, Anaesthetic Gas Scavenging Systems (AGSS), Suction, Flowmeters, Electric Suction, Regulators and more.

With over 40 years experience in the medical gas industry, the company has developed a strong reputation for design, manufacture, quality and excellent customer service with full technical support and advice.

Our in-house machine shop utilises the latest CNC technology allowing us to cope with most manufacturing requirements. Coupled with in house design, we can adapt to our customers needs and requirements, allowing us to have a quicker response, and offer excellent customer service.

To order by email, web, fax or post please forward your purchase order to:

MEC Medical Ltd | Unit 3, Trust Industrial Estate, Wilbury Way, Hitchin, Hertfordshire, SG4 0UZ, United Kingdom

☎ +44 (0) 1462 436 396 sales@mecmedical.com www.mecmedical.com

All major credit cards accepted.

NOTES

1. Although every effort is made to maintain the prices as listed, MEC Medical Ltd reserves the right to amend specification and/or prices without prior notification.
2. All prices are in UK Pounds Sterling, Nett, Ex-Works, exclusive of packing, delivery and VAT.
3. Please quote the catalogue reference number or part number and description on your order. If in doubt please do not hesitate to contact the MEC Medical sales office for assistance.
4. Due to a policy of continual improvement, product appearance may vary from photographs.
5. Terms and Conditions are available on request.
6. Prices effective from date of publication.
7. Quoted standards correct at time of publication.

CONTENTS

HOSES HOSE ASSEMBLIES	04 - 07
HOSES HOSE REFURBISHMENT	08
HOSES ACCESSORIES	09
HOSES CUSTOMISED ASSEMBLIES	09
PROBES	10
PROBES + NISTS	11 - 13
PROBES + NISTS INTERNATIONAL	14 - 15
TERMINAL UNITS ORB SMOOTHFLOW	16 - 17
TERMINAL UNITS DOUBLE TERMINAL UNITS AND ACCESSORIES	17 - 18
FLOWMETERS BOBBIN FLOWMETERS	18 - 21
FLOWMETERS DIAL FLOWMETERS	22
REGULATORS SINGLE STAGE REGULATORS	22 - 24
REGULATORS COMPACT REGULATORS	24 - 25
REGULATORS DIAL FLOW REGULATORS	25 - 27
REGULATORS TWO STAGE REGULATORS	27 - 29
REGULATORS PRESSURE REDUCING REGULATORS	29
SUCTION SUCTION CONTROLLERS	30
SUCTION SUCTION UNITS	31
SUCTION INJECTOR SUCTION	31
SUCTION ELECTRIC SUCTION	32 - 33
SUCTION PORTABLE SUCTION	33 - 34
AMBULANCE ORB PIPELINE SYSTEMS	34 - 35
AMBULANCE TERMINAL UNITS	35 - 36
AMBULANCE CHANGE OVER UNITS	36 - 40
DEMAND VALVES	41
GAS SPECIFIC SCHRADER ADAPTERS	42 - 45
PENDANTS TERMINAL UNITS	46
PENDANTS SPLITTER UNIT	47
ANAESTHETIC GAS SCAVENGING SYSTEMS	47
PURAIR SCAVENGING SYSTEMS	48
PERSONAL MONITORS	49
EQUIPMENT MOUNTING BRACKETS	49 - 50
EQUIPMENT MOUNTING RAILS	51
EQUIPMENT MOUNTING DRIP MOUNTING AND STANDS	51 - 52
CYLINDER TROLLEYS AND BRACKETS	53
MEDICAL CYLINDER CHART	54
EMERGENCY KITS	55
CHANGE OVER VALVE HOSE ASSEMBLY	55
TEST EQUIPMENT	56 - 63
TEST EQUIPMENT RECALIBRATION	64
SCAVENGING PLANT SINGLE PHASE	65
SCAVENGING PLANT THREE PHASE	65
PLANT	66
ACCESSORIES AND SPARES	67 - 78

HOSES | HOSE ASSEMBLIES

MEC supplies a complete range of Medical Gas Hoses which are fully compliant to current ISO 5359 for the manufacture of medical gas hose assemblies. All hoses are CE marked.

- 3M coloured gas specific anti-static hose
- British standard remote probe
- Phthalate free
- Anti-Microbial



HA1

Hose Assembly - 3m

BS Probe - NIST Probe + Nut

- NIST Probe + NIST Nut
- MRI compatible

GAS	PART No.	PRICE Ea.
O2	HA1	£37.75
O2/N2O	HA2	£37.75
N2O	HA3	£37.75
Air-7	HA4	£37.75
Air-4	HA5	£37.75
Vacuum	HA6	£37.75



HA5RA

Hose Assembly - 3m

BS Right Angle Probe - NIST Probe + Nut

- British standard remote probe 90°
- NIST Probe + NIST Nut
- MRI compatible

GAS	PART No.	PRICE Ea.
O2	HA1RA	£47.75
O2/N2O	HA2RA	£47.75
N2O	HA3RA	£47.75
Air-7	HA4RA	£47.75
Air-4	HA5RA	£47.75
Vacuum	HA6RA	£47.75



HA1SRV

Hose Assembly - 3m

BS Probe Slow Release Valve - NIST Probe + Nut

- Slow release valve for comfort release when disconnecting from outlet point
- MRI compatible

GAS	PART No.	PRICE Ea.
O2	HA1SRV	£79.75
O2/N2O	HA2SRV	£79.75
N2O	HA3SRV	£79.75
Air-7	HA4SRV	£79.75
Air-4	HA5SRV	£79.75
Vacuum (Excludes Valve)	HA6SRV	£79.75



HA1RAN

Hose Assembly - 3m

90° NIST Probe + Nut

- 90° NIST Probe + Nut
- MRI compatible

GAS	PART No.	PRICE Ea.
O2	HA1RAN	£47.75
O2/N2O	HA2RAN	£47.75
N2O	HA3RAN	£47.75
Air-7	HA4RAN	£47.75
Air-4	HA5RAN	£47.75
Vacuum	HA6RAN	£47.75



HA1DS

Hose Assembly - 3m

DISS Nut + Hose Tail - BS Probe

- DISS Nut and Hose Tail
- MRI compatible

GAS	PART No.	PRICE Ea.
O2	HA1DS	£39.75
O2/N2O	HA2DS	£39.75
N2O	HA3DS	£39.75
Air-7	HA4DS	£39.75
Air-4	HA5DS	£39.75
Vacuum	HA6DS	£39.75



BHA2

Boom Hose Assembly - 3m

NIST Probe + Nut - NIST Probe + Nut

- NIST Probe + Nut
- Gas specific NIST Probe
- Gas specific NIST Nut
- MRI compatible

GAS	PART No.	PRICE Ea.
O2	BHA1	£37.75
O2/N2O	BHA2	£37.75
N2O	BHA3	£37.75
Air-7	BHA4	£37.75
Air-4	BHA5	£37.75
Vacuum	BHA6	£37.75



19226HA

Schrader Hose Assembly - 3m

BS Probe - Schrader

- British standard gas specific Schrader adaptor

GAS	PART No.	PRICE Ea.
O2	19221HA	£79.00
O2/N2O	19222HA	£79.00
N2O	19223HA	£79.00
Air-7	19224HA	£79.00
Air-4	19225HA	£79.00
Vacuum	19226HA	£79.00



19221HAN

Schrader Hose Assembly - 3m

NIST Probe + Nut - Schrader

- British standard gas specific Schrader adaptor

GAS	PART No.	PRICE Ea.
O2	19221HAN	£79.00
O2/N2O	19222HAN	£79.00
N2O	19223HAN	£79.00
Air-7	19224HAN	£79.00
Air-4	19225HAN	£79.00
Vacuum	19226HAN	£79.00



HA68161

Extension Hose Assembly - 3m

BS Probe - Pendant Outlet

- British standard gas specific pendant head
- MRI compatible

GAS	PART No.	PRICE Ea.
O2	HA68161	£121.75
O2/N2O	HA68162	£121.75
N2O	HA68163	£121.75
Air-7	HA68164	£121.75
Air-4	HA68165	£121.75
Vacuum	HA68166	£121.75
AGSS	231720HEXT	£121.75



601205BT

Hose Assembly - 3m

BS Probe - Twin Schrader 50mm Block

- British Standard gas specific Twin Schrader adaptors

GAS	PART No.	PRICE Ea.
O2	601201BT	£129.50
O2/N2O	601202BT	£129.50
N2O	601203BT	£129.50
Air-7	601204BT	£129.50
Air-4	601205BT	£129.50
Vacuum	601206BT	£129.50



601205BTR

Twin Schrader Hose Assembly

Rail Clamp 50mm Bar - BS Probe 1.5m

- British Standard gas specific Twin Schrader adaptors

GAS	PART No.	PRICE Ea.
O2	601201BTR	£149.75
O2/N2O	601202BTR	£149.75
N2O	601203BTR	£149.75
Air-7	601204BTR	£149.75
Air-4	601205BTR	£149.75
Vacuum	601206BTR	£149.75



601206BTRL

Twin Schrader Hose Assembly

Rail Clamp 100mm Bar - BS Probe 1.5m

- British Standard gas specific Twin Schrader adaptors

GAS	PART No.	PRICE Ea.
O2	601201BTRL	£149.75
O2/N2O	601202BTRL	£149.75
N2O	601203BTRL	£149.75
Air-7	601204BTRL	£149.75
Air-4	601205BTRL	£149.75
Vacuum	601206BTRL	£149.75



HA3BN

Hose Assembly - 3m

3/8" BSP Bullnose Probe + 3/8" BSP Nut - BS Probe

- 3/8" BSP Nut
- Bullnose probe tail
- MRI compatible

GAS	PART No.	PRICE Ea.
O2	HA1BN	£37.75
O2/N2O	HA2BN	£37.75
N2O	HA3BN	£37.75
Air-7	HA4BN	£37.75
Air-4	HA5BN	£37.75
Vacuum	HA6BN	£37.75



BHA1008

Hose Assembly - 3m

NIST Probe + Nut - 3/8" BSP Bullnose Probe + 3/8" BSP Nut

- 3/8" BSP Nut
- Bullnose probe tail
- Gas specific NIST Probe
- Gas specific NIST Nut
- MRI compatible

GAS	PART No.	PRICE Ea.
O2	BHA1008	£37.75
O2/N2O	BHA2008	£37.75
N2O	BHA3008	£37.75
Air-7	BHA4008	£37.75
Air-4	BHA5008	£37.75
Vacuum	BHA6008	£37.75



008HA4

Hose Assembly - 3m

3/8" BSP Bullnose Probe + 3/8" BSP Nut - 3/8" BSP Bullnose Probe + 3/8" BSP Nut

- 3/8" BSP Nut
- Bullnose probe tail
- MRI compatible

GAS	PART No.	PRICE Ea.
O2	008HA1	£37.75
O2/N2O	008HA2	£37.75
N2O	008HA3	£37.75
Air-7	008HA4	£37.75
Air-4	008HA5	£37.75
Vacuum	008HA6	£37.75



201902HA

Twin Schrader Adaptors + Hose Assembly - 3m

BS Probe - Twin Schraders

- British standard gas specific Twin Schrader adaptors

GAS	PART No.	PRICE Ea.
O2	201901HA	£129.50
O2/N2O	201902HA	£129.50
N2O	201903HA	£129.50
Air-7	201904HA	£129.50
Air-4	201905HA	£129.50
Vacuum	201906HA	£129.50



601201SH

Schrader Hose with Rail Mount - 1m

- 1m coloured gas specific anti-static hose
- British standard gas specific Schrader adaptor on rail clamp

GAS	PART No.	PRICE Ea.
O2	601201SH	£83.75
O2/N2O	601202SH	£83.75
N2O	601203SH	£83.75
Air-7	601204SH	£83.75
Air-4	601205SH	£83.75
Vacuum	601206SH	£83.75



601201SHT

Schrader Hose with Rail Mount - 1m Twin Version

- 1m coloured gas specific anti-static hose
- British standard gas specific Twin Schrader adaptors on rail clamp

GAS	PART No.	PRICE Ea.
O2	601201SHT	£149.50
O2/N2O	601202SHT	£149.50
N2O	601203SHT	£149.50
Air-7	601204SHT	£149.50
Air-4	601205SHT	£149.50
Vacuum	601206SHT	£149.50



FPH4RA

Hose Assembly - 5m

Male NIST - Female NIST 90°

- AGSS versions available for all manufacturers outlets
- MRI compatible

GAS	PART No.	PRICE Ea.
O2	FPH1RA	£56.75
O2/N2O	FPH2RA	£56.75
N2O	FPH3RA	£56.75
Air-7	FPH4RA	£56.75
Air-4	FPH5RA	£56.75
Vacuum	FPH6RA	£56.75
AGSS		POA



BHA1FN

Hose Assembly - 3m

Male NIST - Female NIST

- AGSS versions available for all manufacturers outlets
- MRI compatible

GAS	PART No.	PRICE Ea.
O2	BHA1FN	£39.75
O2/N2O	BHA2FN	£39.75
N2O	BHA3FN	£39.75
Air-7	BHA4FN	£39.75
Air-4	BHA5FN	£39.75
Vacuum	BHA6FN	£39.75
AGSS		POA



HA5MS

Hose Assembly - 3m

NIST Probe + Nut - Mini Schrader Probe

- Gas specific Mini Schrader
- Gas specific NIST Nut
- MRI compatible

GAS	PART No.	PRICE Ea.
O2	HA1MS	£37.75
Air-4	HA5MS	£37.75



HA3BLK

Hose Assembly - 3m

BS Probe - Pin Index Adaptor

- Pin index adaptor
- MRI compatible

GAS	PART No.	PRICE Ea.
O2	HA1BLK	£67.75
N2O	HA3BLK	£67.75



HA7INS14X1

CO2 Insufflator Hose Assembly - High Pressure

1/4" BSP or 7/16" JIC - CO2 Pin Index Yoke

1/4" BSP - Pin Index Yoke

LENGTH	PART No.	PRICE Ea.
1M	HA7INS14X1	£240.00
2M	HA7INS14X2	£260.00
3M	HA7INS14	£280.00

7/16" JIC - CO2 Pin Index Yoke

LENGTH	PART No.	PRICE Ea.
1M	HA7JIC716X1	£240.00
2M	HA7JIC716X2	£260.00
3M	HA7JIC716	£280.00

- CO2 Pin index yoke
- High pressure assembly
- For direct connection to CO2 Pin index bottles

Other Connectors Available | (1M shown)

HOSES | REFURBISHMENT SERVICE

Send your existing hose assembly OR your probes only, attached to 150mm (6") of Hose to **MEC**. **MEC** will inspect the condition and tolerances of your existing connectors. We will re-work with a new Gas Hose (Manufactured to current standards) + a new traceable I.D shrink Sleeve and O ring for NIST Probe + Test. (Out of tolerance Probes or NISTs can be replaced at time of rebuild – **MEC** will contact you to advise of any defects before commencing work). We can only refurbish hoses with probes manufactured by **MEC**, other manufacturers probes we will replace at a discounted rate.

Hose Assembly - 3m

Refurbishment



RECHA1X3

O2 Assembly shown

GAS	PART No.	PRICE Ea.
O2	RECHA1X3	£17.95
O2/N2O	RECHA2X3	£17.95
N2O	RECHA3X3	£17.95
Air-7	RECHA4X3	£17.95
Air-4	RECHA5X3	£17.95
Vacuum	RECHA6X3	£17.95

Hose Assembly - 4m

Refurbishment



RECHA4X4

Air-7 Assembly shown

GAS	PART No.	PRICE Ea.
O2	RECHA1X4	£19.95
O2/N2O	RECHA2X4	£19.95
N2O	RECHA3X4	£19.95
Air-7	RECHA4X4	£19.95
Air-4	RECHA5X4	£19.95
Vacuum	RECHA6X4	£19.95

Hose Assembly - 5m

Refurbishment



RECHA6X5

Vacuum Assembly shown

GAS	PART No.	PRICE Ea.
O2	RECHA1X5	£21.75
O2/N2O	RECHA2X5	£21.75
N2O	RECHA3X5	£21.75
Air-7	RECHA4X5	£21.75
Air-4	RECHA5X5	£21.75
Vacuum	RECHA6X5	£21.75

MEC has a proven history in the manufacture of medical gas products. With the reputation of our products and patient safety in mind we offer a refurbishment service for hoses and connectors.



119201R

Anti-Static Hose 30m Roll PVC

12.3mm od x 6.3mm id

- Manufactured to ISO 5359
- Exceptional performance and renowned for reliability
- Reinforced anti-static, low toxic liner
- Cadmium and silicone free
- Resistant to a wide range of chemicals
- Phthalate free
- Anti-Microbial

COLOUR	PART No.	PRICE Ea.
White - O2	119201R	£88.00
Black - Air	119202R	£88.00
Black/White - Air	119202BWR	£88.00
Blue - N2O	119203R	£88.00
Yellow - Vacuum	119204R	£88.00
Blue/White - N2O/O2	119207R	£88.00
Grey - CO2	119205R	£88.00
Yellow - Vacuum 8mm ID	119204/8IDR	£99.00



119202PHR

Anti-Static Hose 30m Roll Polyurethane

12.7mm od x 6.7mm id

- Manufactured to current European Standard
- Does not contain plasticisers in any form
- Will not work harden
- Phthalate free
- Odour free

COLOUR	PART No.	PRICE Ea.
White - O2	119201PHR	£165.00
Black - Air	119202PHR	£165.00
Blue - N2O	119203PHR	£165.00
Yellow - Vacuum	119204PHR	£165.00
Grey - CO2	119205PHR	£165.00
Blue/White - N2O/O2	119207PHR	£165.00
Brown/White - Heliox	119209PHR	£165.00



4131

Ferrule

For Anti-Static Hoses (left)

- Stainless steel
- Site hole indicator

DESCRIPTION	PART No.	PRICE Ea.
Ferrule	4131	£0.60



CS1P

Heat Shrinking Sleeving

25mm Length - Pack 10

COLOUR	PART No.	PRICE Ea.
White	CS1P	£2.75
Black	CS2P	£2.75
Blue	CS3P	£2.75
Yellow	CS4P	£2.75

HOSES | CUSTOMISED ASSEMBLIES

Now you can put together a complete enquiry for any Hose Assemblies you need by simply visiting the link to our web site '**Hose Configurator**' page. Simply select a Gas type (e.g. Oxygen), the inlet fitting and outlet fitting from the image icons, using the scroll arrows to access the full range.

Then add the flexible hose length and the quantity you require. Finally press '**Build Hose**' to have the specification assemble on screen. At this stage you can press '**Build Another**' to add further assemblies. Finally fill in the short form and press '**Send**'.

This way you can put together a complex order of Hose Assemblies clearly and quickly to send directly to us at MEC via email.

We are always happy to help or provide further information: Telephone us on **+44 (0) 1462 436 396**. Email us at sales@mecmedical.com

PROBES



RP2

Remote BS Probe

To BS 5682

- Stainless steel
- One piece construction
- Gas specific engraving
- Machined to BS 5682
- MRI compatible

GAS	PART No.	PRICE Ea.
O2	RP1	£13.25
O2/N2O	RP2	£13.25
N2O	RP3	£13.25
Air-7	RP4	£13.25
Air-4	RP5	£13.25
Vacuum	RP6	£13.25
Heliox	RP9	£17.25



RP1RA

Remote Right Angled BS Probe

To BS 5682

- Stainless steel
- Gas specific engraving
- Machined to BS 5682
- MRI compatible

GAS	PART No.	PRICE Ea.
O2	RP1RA	£26.25
O2/N2O	RP2RA	£26.25
N2O	RP3RA	£26.25
Air-7	RP4RA	£26.25
Air-4	RP5RA	£26.25
Vacuum	RP6RA	£26.25



DP1

Direct BS Probe

3/8" BSP Thread to BS 5682

- Stainless steel
- One piece construction
- Gas specific engraving
- Machined to BS 5682
- MRI compatible

GAS	PART No.	PRICE Ea.
O2 - Direct	DP1	£12.25
O2/N2O - Direct	DP2	£12.25
N2O - Direct	DP3	£12.25
Air-7 - Direct	DP4	£12.25
Air-4 - Direct	DP5	£12.25
Vacuum - UNF LH Thread	DP6	£16.25
Vacuum - Direct	DP6S	£12.25
Heliox - Direct	DP9	£15.00



DP1M14X1

Direct BS Probe

M14x1 Thread to BS 5682

- Stainless steel
- One piece construction
- Gas specific engraving
- Machined to BS 5682
- MRI compatible

GAS	PART No.	PRICE Ea.
O2	DP1M14X1	£12.25
O2/N2O	DP2M14X1	£12.25
N2O	DP3M14X1	£12.25
Air-7	DP4M14X1	£12.25
Air-4	DP5M14X1	£12.25



DP1DISS

O2 Direct BS Probe

9/16" UNF DISS Thread

GAS	PART No.	PRICE Ea.
O2	DP1DISS	£25.00

PROBES AND NISTS



14186

NIST Probe

With 'O' Ring + Nut to ISO 18082

- Stainless steel NIST Probe with 'O' Ring
- Gas specific engraving on NIST Probe and Nut
- Gas specific Indexing
- MRI compatible

GAS	PART No.	PRICE Ea.
O2	14181	£14.50
O2/N2O	14182	£14.50
N2O	14183	£14.50
Air-7	14184	£14.50
Air-4	14185	£14.50
Vacuum	14186	£14.50
CO2	14187	£14.50
Heliox [He ≤ 80% (Volume Fraction)]	14189	£14.50
AGSS (To fit MEC female NIST only)	231750	£17.25



14163

NIST Probe with 'O' Ring

- Stainless steel NIST Probe with 'O' Ring
- Gas specific Indexing
- Gas specific engraving on NIST Probe
- MRI compatible

GAS	PART No.	PRICE Ea.
O2	14161	£8.00
O2/N2O	14162	£8.00
N2O	14163	£8.00
Air-7	14164	£8.00
Air-4	14165	£8.00
Vacuum	14166	£8.00
CO2	141610	£8.00
Heliox [He ≤ 80% (Volume Fraction)]	14169	£8.00
AGSS	231732	£9.75



14141

NIST Nut

- Plated brass nut
- Gas specific engraving on NIST Nut
- MRI compatible

GAS	PART No.	PRICE Ea.
O2	14141	£7.00
O2/N2O	14142	£7.00
N2O	14143	£7.00
Air-7	14144	£7.00
Air-4	14145	£7.00
Vacuum	14146	£7.00
CO2	14147	£7.00
Heliox	14149	£7.00
AGSS	231733	£8.00



6816214

NIST with Tail

With Non-Return Valve (Not Vacuum)

- Gas specific Female NIST
- Gas specific engraving on Female NIST
- MRI compatible

GAS	PART No.	PRICE Ea.
O2	6816211	£26.75
O2/N2O	6816212	£26.75
N2O	6816213	£26.75
Air-7	6816214	£26.75
Air-4	6816215	£26.75
Vacuum	6816216	£26.75



681631T

NIST with Tail

Without Non-Return Valve

- Gas specific Female NIST
- Gas specific engraving on Female NIST
- MRI compatible

GAS	PART No.	PRICE Ea.
O2	681631T	£17.75
O2/N2O	681632T	£17.75
N2O	681633T	£17.75
Air-7	681634T	£17.75
Air-4	681635T	£17.75
Vacuum	681636T	£17.75



6816213RA

Right Angled Female NIST

Without Non-Return Valve

- Gas specific Female NIST
- Gas specific engraving on Female NIST
- MRI compatible

GAS	PART No.	PRICE Ea.
O2	6816211RA	£29.75
O2/N2O	6816212RA	£29.75
N2O	6816213RA	£29.75
Air-7	6816214RA	£29.75
Air-4	6816215RA	£29.75
Vacuum	6816216RA	£29.75

PROBES AND NISTS



14161RA

Right Angled Male NIST

- Gas specific Male NIST
- Gas specific engraving
- MRI compatible

GAS	PART No.	PRICE Ea.
O2	14161RA	£29.95
O2/N2O	14162RA	£29.95
N2O	14163RA	£29.95
Air-7	14164RA	£29.95
Air-4	14165RA	£29.95
Vacuum	14166RA	£29.95



008BNA

BN Probe

+ BSP Hex Nut Assembly

PART No.	PRICE Ea.
008BNA (3/8" BSP)	£10.25
009BNA (1/4" BSP)	£10.25



008

BN Probe Tail

PART No.	PRICE Ea.
008 (For use with 3/8" Nut)	£6.75
009 (For use with 1/4" Nut)	£6.75



P202293

BSP Hex Nut Plated

PART No.	PRICE Ea.
P202293 (3/8" BSP)	£4.00
P202297 (1/4" BSP)	£4.00



3601518BS

Female NIST

1/8" BSP Thread

GAS	PART No.	PRICE Ea.
O2	3601118BS	£29.95
Air-4	3601518BS	£29.95



Custom NISTS and Probes

MEC can provide a range of custom NISTS and Probes with different threads and fittings.

Please contact us to discuss your requirements.

PROBES AND NISTS



163610

Ceiling NIST Blanking Plug

- Universal NIST for blanking pressure gases

GAS	PART No.	PRICE Ea.
Pressure Gas	163610	£12.75
AGSS	163620	£12.75



3601

Ceiling NIST - Female

Copper Tube - 15mm Dia - 150mm Length

- Gas specific Female NIST
- Gas specific engraving
- MRI compatible

GAS	PART No.	PRICE Ea.
O2	3601	£29.95
O2/N2O	3602	£29.95
N2O	3603	£29.95
Air-7	3604	£29.95
Air-4	3605	£29.95
Vacuum	3606	£29.95
CO2	3607	£37.75
Nitrogen	3608	£37.75
AGSS	231724	£29.95



3601RA

Ceiling NIST - Female 90°

Copper Tube - 15mm Dia - 150mm Length

- Gas specific Female NIST
- Gas specific engraving
- MRI compatible

GAS	PART No.	PRICE Ea.
O2	3601RA	£31.75
O2/N2O	3602RA	£31.75
N2O	3603RA	£31.75
Air-7	3604RA	£31.75
Air-4	3605RA	£31.75
Vacuum	3606RA	£31.75
CO2	3607RA	£39.75
Nitrogen	3608RA	£39.75
AGSS	231724RA	£31.75



3601N

Ceiling NIST - Male

Copper Tube - 15mm Dia - 150mm Length

- Gas specific Male NIST
- Gas specific engraving
- MRI compatible

GAS	PART No.	PRICE Ea.
O2	3601N	£43.50
O2/N2O	3602N	£43.50
N2O	3603N	£43.50
Air-7	3604N	£43.50
Air-4	3605N	£43.50
Vacuum	3606N	£43.50
CO2	3607N	£43.50
Nitrogen	3608N	£43.50
AGSS	231724N	£43.50



3601NRA

Ceiling NIST - Right Angled Male

Copper Tube - 15mm Dia - 150mm Length

- Gas specific Male NIST
- Gas specific engraving
- MRI compatible

GAS	PART No.	PRICE Ea.
O2	3601NRA	£43.50
O2/N2O	3602NRA	£43.50
N2O	3603NRA	£43.50
Air-7	3604NRA	£43.50
Air-4	3605NRA	£43.50
Vacuum	3606NRA	£43.50
CO2	3607NRA	£43.50
Nitrogen	3608NRA	£43.50
AGSS	231724NRA	£43.50



14160P

NIST Spares

GAS	PART No.	PRICE Ea.
NIST Probe 'O' Ring Pack 10	14160P	£2.50



53100026

DISS Female

Nut + Hose Tail (North American Standard)

GAS	PART No.	PRICE Ea.
O2	53100025	£13.75
N2O	53100026	£13.75
Air	53100027	£13.75
Vacuum	53100028	£13.75
CO2	53100029	£13.75
Instrument Air	53100024	£13.75



53100070

Ohmeda[®] Probe

(North American Standard)

GAS	PART No.	PRICE Ea.
O2	53100067	£27.75
N2O	53100068	£27.75
Air	53100069	£27.75
Vacuum	53100070	£27.75



53100065

Puritan[®] Probe

(North American Standard)

GAS	PART No.	PRICE Ea.
O2	53100063	£27.75
N2O	53100064	£27.75
Air	53100065	£27.75
Vacuum	53100066	£27.75



53100071

Chemetron[®] Probe

(North American Standard)

GAS	PART No.	PRICE Ea.
O2	53100071	£27.75
N2O	53100072	£27.75
Air	53100073	£27.75
Vacuum	53100074	£27.75



53100031

DISS Male

(USA Standard)

GAS	PART No.	PRICE Ea.
O2	53100031	£11.50
Air	53100032	£11.50



53100038

DIN Remote Probes

(German Standard)

GAS	PART No.	PRICE Ea.
O2	53100038	£19.75
N2O	53100039	£19.75
Air ('D' Shape Surgical)	53100040	£19.75
Vacuum	53100041	£19.75
Medical Air (Square)	53100042	£19.75
CO2	53100043	£19.75



53100050

AGA Remote Probe (Scandinavian Standard)

GAS	PART No.	PRICE Ea.
O2	53100050	£17.25
Air	53100051	£17.25
N2O	53100052	£17.25
Vacuum	53100053	£17.25



53100050RA

AGA Right Angle Probe (Scandinavian Standard)

GAS	PART No.	PRICE Ea.
O2	53100050RA	£25.00
Air	53100051RA	£25.00



180172

AFNOR Remote Probe (French Standard)

GAS	PART No.	PRICE Ea.
O2	180170	£27.75
N2O	180171	£27.75
Air	180172	£27.75
Vacuum	180173	£27.75



53100100

UNIFOR Remote Probe (Italian Standard)

GAS	PART No.	PRICE Ea.
O2	53100100	£27.75
N2O	53100102	£27.75
Air-4	53100101	£27.75
Surgical Air	53100103	£27.75
Vacuum	53100104	£27.75



531038RA

DIN 90° (German Standard)

GAS	PART No.	PRICE Ea.
O2	531038RA	£25.00
N2O	531039RA	£25.00
Air ('D' Shape Surgical)	531040RA	£25.00
Vacuum	531041RA	£25.00
Medical Air (Square)	531042RA	£25.00
CO2	531043RA	£25.00

MEC stocks a wide range of international medical gas fittings. Hose assemblies for both ISO and US standards can be manufactured to customers requirements.



MEC's medical case outlet is fully compliant to the requirements of ISO 9170-1. The terminal units feature a larger 51mm collar which is completely smooth, reducing the chance of dirt build up. The terminal unit also includes two independent springs for balance and durability. All second fix parts and boxes include a silver antimicrobial additive for inherent antimicrobial protection.

- Gas specific sockets with non-interchangeability
- First Fix supplied with a length of copper pipe
- Complete with fixing screws to secure both First Fix and Box to base plate
- First and Second Fix supplied
- Fully compliant with all current standards



S202101N

ORB Smoothflow Surface Terminal Units

GAS	PART No.	PRICE Ea.
O2	S202101N	£39.75
O2/N2O	S202102N	£39.75
N2O	S202103N	£39.75
Air-7	S202104N	£39.75
Air-4	S202105N	£39.75
Vacuum	S202106N	£39.75
Heliox	S202109N	£49.75
CO2	S202107N	£79.75
N2	S202108N	£79.75
AGSS	S231700N	£49.75



F202104N

ORB Smoothflow Flush Terminal Units

GAS	PART No.	PRICE Ea.
O2	F202101N	£39.75
O2/N2O	F202102N	£39.75
N2O	F202103N	£39.75
Air-7	F202104N	£39.75
Air-4	F202105N	£39.75
Vacuum	F202106N	£39.75
Heliox	F202109N	£49.75
CO2	F202107N	£79.75
N2	F202108N	£79.75
AGSS	F231700N	£49.75



T202106N

ORB Smoothflow Trunking Terminal Units

GAS	PART No.	PRICE Ea.
O2	T202101N	£39.75
O2/N2O	T202102N	£39.75
N2O	T202103N	£39.75
Air-7	T202104N	£39.75
Air-4	T202105N	£39.75
Vacuum	T202106N	£39.75
Heliox	T202109N	£49.75
CO2	T202107N	£79.75
N2	T202108N	£79.75
AGSS	T231700N	£49.75



B202101N

ORB Smoothflow Boom Terminal Units

Female NIST Fitting

GAS	PART No.	PRICE Ea.
O2	B202101N	£39.75
O2/N2O	B202102N	£39.75
N2O	B202103N	£39.75
Air-7	B202104N	£39.75
Air-4	B202105N	£39.75
Vacuum	B202106N	£39.75

GAS	PART No.	PRICE Ea.
Heliox	B202109N	£49.75
CO2	B202107N	£79.75
N2	B202108N	£79.75
AGSS	B231700N	£49.75

TERMINAL UNITS | ORB SMOOTHFLOW



- Supplied with gas specific Male NIST
- Complete with fixing screws to secure outlet



- Supplied with gas specific Male NIST
- Complete with fixing screws to secure outlet

R202101

ORB Smoothflow Straight Exit Pendant Units

With Male NIST

GAS	PART No.	PRICE Ea.
O2	R202101	£39.75
O2/N2O	R202102	£39.75
N2O	R202103	£39.75
Air-7	R202104	£39.75
Air-4	R202105	£39.75
Vacuum	R202106	£39.75
CO2	R202107	£79.75
N2	R202108	£79.75
AGSS	R231700	£49.75

A202103

ORB Smoothflow 45° Exit Pendant Units

GAS	PART No.	PRICE Ea.
O2	A202101	£39.75
O2/N2O	A202102	£39.75
N2O	A202103	£39.75
Air-7	A202104	£39.75
Air-4	A202105	£39.75
Vacuum	A202106	£39.75
CO2	A202107	£79.75
N2	A202108	£79.75
AGSS	A231700	£49.75

TERMINAL UNITS | DOUBLE TERMINAL UNITS AND ACCESSORIES

The **MEC** Double Terminal Units are a valuable and cost effective option when an extra outlet point is required. With no installation, the unit can be rail or wall mounted and for positioning flexibility, it is connected with a one metre hose assembly. The units fully conform with ISO 9170-1.



R40201

Double Terminal Unit

With 1m Hose Assembly

Wall Fixing

GAS	PART No.	PRICE Ea.
O2	W40201	£199.50
O2/N2O	W40202	£199.50
N2O	W40203	£199.50
Air-7	W40204	£199.50
Air-4	W40205	£199.50
Vacuum	W40206	£199.50

Rail Fixing

GAS	PART No.	PRICE Ea.
O2	R40201	£199.50
O2/N2O	R40202	£199.50
N2O	R40203	£199.50
Air-7	R40204	£199.50
Air-4	R40205	£199.50
Vacuum	R40206	£199.50

- Twin gas specific outlet points
- 1m of gas specific hose with BS Probe
- Wall or Rail mounting
- Fully conforming with ISO 9170-1

Alternative hose lengths may be specified at time of order

TERMINAL UNITS | DOUBLE TERMINAL UNITS AND ACCESSORIES



40208

Brackets

DESCRIPTION	PART No.	PRICE Ea.
Wall Mounting Bracket	40208	£12.50
Rail Mounting Bracket	40207	£12.50



40207



H40206

Hose Assembly - 1m

GAS	PART No.	PRICE Ea.
O2	H40201	£41.00
O2/N2O	H40202	£41.00
N2O	H40203	£41.00
Air-7	H40204	£41.00
Air-4	H40205	£41.00
Vacuum	H40206	£41.00

- 1m coloured gas specific anti-static hose
- British Standard remote probe
- Cover assembly included
- For use with MEC Double Terminal Units

FLOWMETERS | BOBBIN FLOWMETERS

The **MEC** Flowmeter range fully complies with the requirements of ISO15002 Flow metering devices for the connection to terminal units of medical gas pipeline systems. **MEC's** Flowmeters are calibrated to operate from an inlet pressure of 4 Bar (approx. 60psi) and carry a 7 year function warranty.

- Anodised aluminium body
- Polycarbonate inner outer tube
- Acetal spindle
- White/black Acetal Plastic tubing nipple



60151

Single Flowmeter

3/8" BSP Nut + Liner

GAS	PART No.	PRICE Ea.
O2 High Flow 0-15Lpm	60151	£30.00
O2 Low Flow 0.15-4.5Lpm	6021	£60.00
Air-4 High Flow 0-15Lpm	60155	£30.00
Air-4 Low Flow 0.15-4.5Lpm	6025	£60.00



6015DP1

Single Flowmeter

Fixed BS Probe

GAS	PART No.	PRICE Ea.
O2 High Flow 0-15Lpm	6015DP1	£35.00
O2 Low Flow 0.15-4.5Lpm	6021DP1	£65.00
Air-4 High Flow 0-15Lpm	6015DP5	£35.00
Air-4 Low Flow 0.15-4.5Lpm	602DP5	£65.00



60151HA1X1

Rail Mounted Single Flowmeter

With 1m Hose Assembly
GAS

GAS	PART No.	PRICE Ea.
O2 High Flow 0-15Lpm	60151HA1X1	£69.50
Air-4 High Flow 0-15Lpm	60155HA5X1	£69.50



206215HA5X1

Rail Mounted Double Flowmeter

BS Probe

GAS	PART No.	PRICE Ea.
O2 High Flow 0-15Lpm	206211HA1X1	£128.50
O2 Low Flow 0.15-4.5Lpm	206021HA1X1	£188.50
Air-4 High Flow 0-15Lpm	206215HA5X1	£128.50
Air-4 Low Flow 0.15-4.5Lpm	206025HA1X1	£188.50



206211NL

Double Flowmeters

3/8" BSP Nut + Liner

GAS	PART No.	PRICE Ea.
O2 High Flow 0-15Lpm	206211NL	£88.50
O2 Low Flow 0.15-4.5Lpm	206021NL	£148.50
Air-4 High Flow 0-15Lpm	206215NL	£88.50
Air-4 Low Flow 0.15-4.5Lpm	206025NL	£148.50



206211DP

Double Flowmeters

With BS Probe

GAS	PART No.	PRICE Ea.
O2 High Flow 0-15Lpm	206211DP	£97.50
O2 Low Flow 0.15-4.5Lpm	206021DP	£157.50
Air-4 High Flow 0-15Lpm	206215DP	£97.50
Air-4 Low Flow 0.15-4.5Lpm	206025DP	£157.50



206211NB

Straight Bar Double Flowmeters

50mm Back Bar - 3/8" BSP Nut + Liner

GAS	PART No.	PRICE Ea.
O2 High Flow 0-15Lpm	206211NB	£88.50
O2 Low Flow 0.15-4.5Lpm	206021NB	£148.50
Air-4 High Flow 0-15Lpm	206215NB	£88.50
Air-4 Low Flow 0.15-4.5Lpm	206025NB	£148.50



206215B

Straight Bar Double Flowmeters

50mm Back Bar - With BS Probe

GAS	PART No.	PRICE Ea.
O2 High Flow 0-15Lpm	206211B	£97.50
O2 Low Flow 0.15-4.5Lpm	206021B	£157.50
Air-4 High Flow 0-15Lpm	206215B	£97.50
Air-4 Low Flow 0.15-4.5Lpm	206025B	£157.50



206025NBL

Straight Bar Double Flowmeters

100mm Back Bar - 3/8" BSP Nut + Liner

GAS	PART No.	PRICE Ea.
O2 High Flow 0-15Lpm	206211NBL	£88.50
O2 Low Flow 0.15-4.5Lpm	206021NBL	£148.50
Air-4 High Flow 0-15Lpm	206215NBL	£88.50
Air-4 Low Flow 0.15-4.5Lpm	206025NBL	£148.50



2060211BL

Straight Bar Double Flowmeters

100mm Back Bar - With BS Probe

GAS	PART No.	PRICE Ea.
O2 High Flow 0-15Lpm	206211BL	£97.50
O2 Low Flow 0.15-4.5Lpm	206021BL	£157.50
Air-4 High Flow 0-15Lpm	206215BL	£97.50
Air-4 Low Flow 0.15-4.5Lpm	206025BL	£157.50



206211SNB

Straight Bar Schrader + Flowmeter

50mm Back Bar - 3/8" BSP Nut + Liner

GAS	PART No.	PRICE Ea.
O2 High Flow 0-15Lpm	206211SNB	£88.50
O2 Low Flow 0.15-4.5Lpm	206021SNB	£148.50
Air-4 High Flow 0-15Lpm	206215SNB	£88.50
Air-4 Low Flow 0.15-4.5Lpm	206025SNB	£148.50



206025SB

Straight Bar Schrader + Flowmeter

50mm Back Bar - With BS Probe

GAS	PART No.	PRICE Ea.
O2 High Flow 0-15Lpm	206211SB	£97.50
O2 Low Flow 0.15-4.5Lpm	206021SB	£157.50
Air-4 High Flow 0-15Lpm	206215SB	£97.50
Air-4 Low Flow 0.15-4.5Lpm	206025SB	£157.50



206211SNBL

Straight Bar Schrader + Flowmeter

100mm Back Bar - 3/8" BSP Nut + Liner

GAS	PART No.	PRICE Ea.
O2 High Flow 0-15Lpm	206211SNBL	£88.50
O2 Low Flow 0.15-4.5Lpm	206021SNBL	£148.50
Air-4 High Flow 0-15Lpm	206215SNBL	£88.50
Air-4 Low Flow 0.15-4.5Lpm	206025SNBL	£148.50



206215SBL

Straight Bar Schrader + Flowmeter

100mm Back Bar - With BS Probe

GAS	PART No.	PRICE Ea.
O2 High Flow 0-15Lpm	206211SBL	£97.50
O2 Low Flow 0.15-4.5Lpm	206021SBL	£157.50
Air-4 High Flow 0-15Lpm	206215SBL	£97.50
Air-4 Low Flow 0.15-4.5Lpm	206025SBL	£157.50



206211NBHA1X1

Straight Bar Rail Mounted

50mm Back Bar - Double Flowmeter on Rail

GAS	PART No.	PRICE Ea.
O2 High Flow 0-15Lpm	206211NBHA1X1	£128.50
O2 Low Flow 0.15-4.5Lpm	206021NBHA1X1	£188.50
Air-4 High Flow 0-15Lpm	206215NBHA5X1	£128.50
Air-4 Low Flow 0.15-4.5Lpm	206025NBHA5X1	£188.50



206215SNBHA5X1

Straight Bar Rail Mounted

50mm Back Bar - Schrader + Flowmeter on Rail

GAS	PART No.	PRICE Ea.
O2 High Flow 0-15Lpm	206211SNBHA1X1	£128.50
O2 Low Flow 0.15-4.5Lpm	206021SNBHA1X1	£188.50
Air-4 High Flow 0-15Lpm	206215SNBHA5X1	£128.50
Air-4 Low Flow 0.15-4.5Lpm	206025SNBHA5X1	£188.50



206025NBLHA5X1

Straight Bar Rail Mounted

100mm Back Bar - Double Flowmeter on Rail

GAS	PART No.	PRICE Ea.
O2 High Flow 0-15Lpm	206211NBLHA1X1	£128.50
O2 Low Flow 0.15-4.5Lpm	206021NBLHA1X1	£188.50
Air-4 High Flow 0-15Lpm	206215NBLHA5X1	£128.50
Air-4 Low Flow 0.15-4.5Lpm	206025NBLHA5X1	£188.50



206211SNBLHA1X1

Straight Bar Rail Mounted

100mm Back Bar - Schrader + Flowmeter on Rail

GAS	PART No.	PRICE Ea.
O2 High Flow 0-15Lpm	206211SNBLHA1X1	£128.50
O2 Low Flow 0.15-4.5Lpm	206021SNBLHA1X1	£188.50
Air-4 High Flow 0-15Lpm	206215SNBLHA5X1	£128.50
Air-4 Low Flow 0.15-4.5Lpm	206025SNBLHA5X1	£188.50

FLOWMETERS | DIAL FLOWMETERS



4961271

Dial Flowmeter + Fixed Probe

- Flow selector with front facing window
- Multiple flow therapy output
1/2, 1, 2, 3, 4, 6, 8, 10 and 15 litres per minute
- Designed for use with 4 bar oxygen supply

DESCRIPTION	PART No.	PRICE Ea.
O2 0.5-15.0 Lpm	4961271	£99.00



4961272

Dual Dial Flowmeter + Fixed Probe

- Flow selector with front facing window
- Twin Multiple flow therapy output
1/2, 1, 2, 3, 4, 6, 8, 10 and 15 litres per minute
- Designed for use with 4 bar oxygen supply

DESCRIPTION	PART No.	PRICE Ea.
O2 0.5-15.0 Lpm	4961272	£166.00



4961273

4 Way Flow Selector and Frame

+ BS Schrader Input Probe on 2m Hose

- Strong aluminium frame
- Extending hooks for hanging
- 2m supply hose to connect to 4 bar oxygen source
- Folding carrying handle
- Four therapy outlets, each with selectable flows,
1/2, 1, 2, 3, 4, 6, 8, 10 and 15 litres per minute
- Plastic feet to base

DESCRIPTION	PART No.	PRICE Ea.
4 Way Flow Selector	4961273	£665.00

REGULATORS | SINGLE STAGE REGULATORS

The MEC range of Single Stage Medical Regulators are designed and manufactured to fully comply with ISO 10524-1

- 200 bar maximum inlet pressure
- 4 bar pre-set delivery pressure
- Maximum flow rate – 50 l/min
- Bullnose or Pin Index inlet connections available
- Nickel plated inlet and outlet connections
- Robust brass body construction for prolonged service life
- Serial number and replacement date, clearly marked on rear of regulator



6060

Single Stage Regulator

3/8" BSP Outlet

DESCRIPTION	PART No.	PRICE Ea.
O2 Bullnose	6080	£69.50
Air-4 Bullnose	6081	£69.50
N2O Nut + Stem	6083	£123.50
O2 Pin Index	6060	£102.50
Air-4 Pin Index	6061	£102.50
N2O Pin Index	6063	£152.50



6080SH

Single Stage Regulator

Including Schrader

DESCRIPTION	PART No.	PRICE Ea.
O2 Bullnose	6080SH	£100.25
Air-4 Bullnose	6081SH	£100.25
N2O Nut + Stem	6083SH	£150.00
O2 Pin Index	6060SH	£133.25
Air-4 Pin Index	6061SH	£133.25
N2O Pin Index	6063SH	£153.25



6060F

Single Stage Regulator

Including Flowmeter 0-15Lpm

DESCRIPTION	PART No.	PRICE Ea.
O2 Bullnose	6060F	£99.00
Air-4 Bullnose	6061F	£99.00
O2 Pin Index	6060SEF	£134.50
Air-4 Pin Index	6061SEF	£134.50

6080FHS

Single Stage Regulator

Including Flowmeter- 0-15Lpm + Disposable Humidifier, Face Mask with 1.8m Tubing + Spanner

DESCRIPTION	PART No.	PRICE Ea.
O2 Pin Index	6060FHS	£147.00
Air-4 Pin Index	6061FHS	£147.00
O2 Bullnose	6080FHS	£113.50
Air-4 Bullnose	6081FHS	£113.50



REGULATORS | COMPACT REGULATORS

MEC Dial Flow Regulators are manufactured with a brass body and choice of Therapy and Schrader outlets. Manufactured to ISO 10524-1.

- Multiple flow therapy output set by a dial 1/2, 1, 2, 3, 4, 6, 8, 10, 15 and MAX 25 litres per minute if specified
- Barbed, fir-tree style connector or Schrader
- Complies with all current standards



4918552

Pin Index Regulator + Schrader - Non Therapy

DESCRIPTION	PART No.	PRICE Ea.
O2 4 bar output	4918552	£135.00
Air-4 4 bar output	4918552A	£135.00

- Oxygen regulator with Pin Index
- Single Schrader outlet



4918552B

Bullnose Regulator + Schrader - Non Therapy

DESCRIPTION	PART No.	PRICE Ea.
O2 4 bar output	4918552B	£135.00
Air-4 4 bar output	4918552BA	£135.00

- Oxygen regulator with Bullnose input
- Single Schrader outlet



4918552BT

Bullnose Regulator + Twin Schrader - Non Therapy

DESCRIPTION	PART No.	PRICE Ea.
O2 4 bar output	4918552BT	£170.00
Air-4 4 bar output	4918552BTA	£170.00

- Oxygen regulator with Bullnose input
- Twin Schrader outlet



4918552T

Pin Index Regulator + Twin Schrader - Non Therapy

DESCRIPTION	PART No.	PRICE Ea.
O2 4 bar output	4918552T	£170.00
Air-4 4 bar output	4918552TA	£170.00

- Oxygen regulator with Pin Index
- Twin Schrader outlet



4918501

Pin Index Regulator + Flowmeter

DESCRIPTION	PART No.	PRICE Ea.
O2 0.5-15.0 Lpm	4918501	£135.00
Air-4 0.5-15.0 Lpm	4918501A	£135.00

- Oxygen regulator with Pin Index
- Multiple flow therapy output set by a dial
- 1/2, 1, 2, 3, 4, 6, 8, 10 and 15 litres per minute



4918501B

Bullnose Regulator - Therapy

DESCRIPTION	PART No.	PRICE Ea.
O2 0.5-15.0 Lpm	4918501B	£135.00
Air-4 0.5-15.0 Lpm	4918501BA	£135.00

- Oxygen regulator with Bullnose input
- Multiple flow therapy output 1/2, 1, 2, 3, 4, 6, 8, 10 and 15 litres per minute



4918551

Pin Index Regulator + Schrader - Therapy

DESCRIPTION	PART No.	PRICE Ea.
O2 0.5-15.0 Lpm	4918551	£175.00
Air-4 0.5-15.0 Lpm	4918551A	£175.00

- Oxygen regulator with Pin Index
- Single Schrader outlet
- Multiple flow therapy output 1/2, 1, 2, 3, 4, 6, 8, 10 and 15 litres per minute



4918551B

Bullnose Regulator + Schrader - Therapy

DESCRIPTION	PART No.	PRICE Ea.
O2 0.5-15.0 Lpm	4918551B	£175.00
Air-4 0.5-15.0 Lpm	498551BA	£175.00

- Oxygen regulator with Bullnose input
- Single Schrader outlet
- Multiple flow therapy output 1/2, 1, 2, 3, 4, 6, 8, 10 and 15 litres per minute

REGULATORS | DIAL FLOW REGULATORS



4918551BT

Bullnose Regulator + Twin Schrader - Therapy

DESCRIPTION	PART No.	PRICE Ea.
O2 0.5-15.0 Lpm	4918551BT	£210.00
Air-4 0.5-15.0 Lpm	4918551BTA	£210.00

- Oxygen regulator with Bullnose input
- Twin Schrader outlet
- Multiple flow therapy output 1/2, 1, 2, 3, 4, 6, 8, 10 and 15 litres per minute



4918551T

Pin Index Regulator + Twin Schrader - Therapy

DESCRIPTION	PART No.	PRICE Ea.
O2 0.5-15.0 Lpm	4918551T	£210.00
Air-4 0.5-15.0 Lpm	4918551TA	£210.00

- Oxygen regulator with Pin Index
- Twin Schrader outlet
- Multiple flow therapy output 1/2, 1, 2, 3, 4, 6, 8, 10 and 15 litres per minute

REGULATORS | DIAL REGULATORS MRI COMPATIBLE

MEC Dial Flow Regulators are non-magnetic and MRI compatible. Built to the same high standard as our Therapy range, the regulators comply with ISO 10524-1 and have a maximum flow capability of 25 litres per minute.

- Multiple flow therapy output set by a dial 1/2, 1, 2, 3, 4, 6, 8, 10, 15 and MAX 25 litres per minute
- Barbed, fir-tree style connector
- Complies with all current standards



4918501MRI

Pin Index Regulator + Flowmeter

- Non-magnetic oxygen regulator with Pin Index input

DESCRIPTION	PART No.	PRICE Ea.
O2 0.5-25.0 Lpm	4918501MRI	£205.00



4918501BMRI

Bullnose Regulator + Flowmeter

- Non-magnetic oxygen regulator with Bullnose input

DESCRIPTION	PART No.	PRICE Ea.
O2 0.5-25.0 Lpm	4918501BMRI	£205.00



4918501CGAMRI

USA Type Regulator + Flowmeter

- Non-magnetic oxygen regulator with CGA-540 (USA) input

DESCRIPTION	PART No.	PRICE Ea.
O2 0.5-25.0 Lpm	4918501CGAMRI	£205.00

REGULATORS | TWO STAGE REGULATORS

The **MEC** range of Multi-Stage Medical Regulators are designed and manufactured to fully comply with ISO 10524-1 for cylinder use and ISO 10524-2 for manifold use.

- 200 bar maximum inlet pressure
- 0-10 bar delivery pressure
- 4/7 bar pre-set delivery pressure
- Maximum flow rate – 42m³/hr
- Cylinder and manifold variants available
- Bullnose or Pin Index inlet connections available
- Robust brass body construction for prolonged service life
- Serial number and replacement date clearly marked on rear of regulator



6070

Two Stage Regulator

3/8" BSP Outlet

DESCRIPTION	PART No.	PRICE Ea.
O2 Bullnose	6070	£175.00
Air-4 Bullnose	6071	£175.00
Air-7 Bullnose	6074	£175.00
N2O Nut + Stem	6073	£230.00



6050

Two Stage Regulator

3/8" BSP Outlet

DESCRIPTION	PART No.	PRICE Ea.
O2 Pin Index	6050	£202.00
Air-4 Pin Index	6051	£202.00
O2/N2O Pin Index	6052	£240.00
N2O Pin Index	6053	£202.00
Air-7 Pin Index	6054	£202.00
CO2 Nut + Stem	6075	£240.00



6071SH

Two Stage Regulator

Including Schrader

DESCRIPTION	PART No.	PRICE Ea.
O2 Bullnose	6070SH	£206.00
Air-4 Bullnose	6071SH	£206.00
Air-7 Bullnose	6071SH4	£206.00
N2O Nut + Stem	6071SH3	£261.00



6051SH

Two Stage Regulator

Including Schrader

DESCRIPTION	PART No.	PRICE Ea.
O2 Pin Index	6050SH	£233.00
Air-4 Pin Index	6051SH	£233.00
O2/N2O Pin Index	6051SH2	£271.00
N2O Pin Index	6051SH3	£233.00
Air-7 Pin Index	6051SH4	£233.00

REGULATORS | TWO STAGE REGULATORS



6070A

Two Stage Adjustable Regulator

3/8" BSP Outlet

DESCRIPTION	PART No.	PRICE Ea.
O2 Bullnose	6070A	£211.50
Air Bullnose	6071A	£211.50
N2O Nut + Stem	6073A	£266.50



6050A

Two Stage Adjustable Regulator

3/8" BSP Outlet

DESCRIPTION	PART No.	PRICE Ea.
O2 Pin Index	6050A	£238.50
Air Pin Index	6051A	£238.50
O2/N2O Pin Index	6052A	£276.50
N2O Pin Index	6053A	£238.50
CO2 Nut + Stem	6075A	£266.50
CO2 Pin Index	6079A	£266.50



6051F

Two Stage Regulator

Including Flowmeter - 0-15Lpm

DESCRIPTION	PART No.	PRICE Ea.
O2 Bullnose	6070F	£204.50
Air-4 Bullnose	6071F	£204.50
O2 Pin Index	6050F	£254.00
Air-4 Pin Index	6051F	£254.00



6070RA

Two Stage Regulator

Including Schrader - Right Angle

DESCRIPTION	PART No.	PRICE Ea.
O2 Bullnose	6070RA	£226.50
Air-4 Bullnose	6071RA	£226.50
O2 Pin Index	6050RA	£253.25
Air-4 Pin Index	6051RA	£253.25



6070SHA

Two Stage Adjustable Regulator

Including Schrader

DESCRIPTION	PART No.	PRICE Ea.
O2 Bullnose	6070SHA	£241.50
Air-4 Bullnose	6071SHA	£241.50
Air-7 Bullnose	6071SH4A	£241.50
N2O Nut + Stem	6071SH3A	£329.50



6051SHA

Two Stage Adjustable Regulator

Including Schrader

DESCRIPTION	PART No.	PRICE Ea.
O2 Pin Index	6050SHA	£274.50
Air-4 Pin Index	6051SHA	£274.50
O2/N2O Pin Index	6051SH2A	£339.50
N2O Pin Index	6051SH3A	£274.50
Air-7 Pin Index	6051SH4A	£274.50

REGULATORS | TWO STAGE REGULATORS



6070RAA

Two Stage Adjustable Regulator

Including Schrader - Right Angle

DESCRIPTION	PART No.	PRICE Ea.
O2 Bullnose	6070RAA	£263.00
Air-4 Bullnose	6071RAA	£263.00
O2 Pin Index	6050RAA	£296.00
Air-4 Pin Index	6051RAA	£296.00

MEC can provide a range of custom manufactured regulators with different inlet connections and output fittings.

REGULATORS | PRESSURE REDUCING REGULATORS



F161818



161818

Pressure Reducing Regulator

DESCRIPTION	PART No.	PRICE Ea.
Adjustable Air-7 Bar to Zero Pressure Regulator	161818	£125.75
O2 Adjustable 8.5 Bar to Zero Pressure Regulator	161818/1	£125.75
N2O Adjustable 8.5 Bar to Zero Pressure Regulator	161818/3	£125.75
Air-7 Adjustable 8.5 Bar to Zero Pressure Regulator	161818/4	£125.75
Air-4 Adjustable 8.5 Bar to Zero Pressure Regulator	161818/5	£125.75
Fixed 7 Bar Input - 4 Bar Output Pressure Regulator	F161818	£123.75

- Supplied with gas specific Schrader
- British Standard gas specific Probe

SUCTION | SUCTION CONTROLLERS

High vacuum is suitable for use in operating theatres, intensive care units, trauma and casualty units, wards and any application where high vacuum is required. The suction controller enables the vacuum to be set at any level from 0 to full pipeline vacuum. The vacuum gauge is marked from 0 to -100 kPa and 0 to -760 mmHg. **Low vacuum** is suitable for paediatric applications or where a vacuum not exceeding -20kPa (-150 mmHg) is required. The vacuum gauge is marked 0 to -27 kPa and 0 to -203 mmHg. *NB: The suction control knob is yellow.* **Thoracic suction** is suitable for abdominal or pleural drainage or where a vacuum not exceeding -7kPa (-53 mmHg) is required. The vacuum gauge is marked 0 to -10 kPa and 0 to -75 mmHg. *NB: The suction control knob is blue.* **Controllers** are supplied with BS probes. Alternative probe types are available, including DIN and ULA probes. Units with remote probes are supplied with 2 metres of vacuum hose. Vacuum controllers are supplied with a gauge (marked in kPa and mmHg), disposable hydrophobic filter that acts as a safety overflow valve, an On/Off switch and vacuum adjustment knob. Manufactured to ISO 10079-3.



FSR445-111215

Suction Controller

On Rail Clamp with Remote BS Probe

DESCRIPTION	PART No.	PRICE Ea.
High Suction	FSR425-111215	£174.00
Low Suction	FSR445-111215	£221.00
Thoracic Suction	FSR465-111215	£257.00



FSR425-111515

Suction Controller

On Direct BS Probe

DESCRIPTION	PART No.	PRICE Ea.
High Suction	FSR425-111515	£141.00
Low Suction	FSR445-111515	£186.00
Thoracic Suction	FSR465-111515	£223.00



FSR465-111715

Suction Controller

On Male 'V' Wedge with Remote BS Probe

DESCRIPTION	PART No.	PRICE Ea.
High Suction	FSR425-111715	£174.00
Low Suction	FSR445-111715	£218.00
Thoracic Suction	FSR465-111715	£254.00



FSP806-111215

Pipeline Suction on Rail Clamp

With 2m Vacuum Hose + Remote BS Probe

DESCRIPTION	PART No.	PRICE Ea.
High Suction	FSP806-111215	£216.00
Low Suction	FSP826-111215	£263.00
Thoracic Suction	FSP846-111215	£286.00

- Suction Controller and Jar both mounted on a rail clamp
- 2m of Vacuum Hose with remote BS Vacuum probe
- 1500ml Autoclavable Polysulphone collection jar



FSP808-113815

Pipeline Suction on Rail Clamp + BS Probe

With Direct BS Probe

DESCRIPTION	PART No.	PRICE Ea.
High Suction	FSP808-113815	£183.00
Low Suction	FSP828-113815	£228.00
Thoracic Suction	FSP848-113815	£263.00

- Suction Controller on a Direct BS Probe
- Suction Jar mounted on a rail clamp
- 1500ml Autoclavable Polysulphone collection jar



FSP808-114115

Pipeline Suction on 'V' Wedge + BS Probe

With Wall 'V' Plate + Direct BS Probe

DESCRIPTION	PART No.	PRICE Ea.
High Suction	FSP808-114115	£181.00
Low Suction	FSP828-114115	£226.00
Thoracic Suction	FSP848-114115	£259.00

- Suction Controller on a Direct BS Probe
- Suction Jar mounted on 'V' Wedge
- 1500ml Autoclavable Polysulphone collection jar

SUCTION | SUCTION UNITS

Suction units are supplied with 1500ml autoclavable polysulphone collection jars, fitted with safety overflow valves. The suction units can be supplied with 2 litre collection jars. Alternative probe types are available.



- Suction Controller with Gauge
- Disposable Bacterial Filter
- Safety Overflow Valve
- Four Autoclavable Jars
- 1800ml capacity

FSP480-121215

Mobile High Vacuum Suction Unit

DESCRIPTION	PART No.	PRICE Ea.
Mobile High Vacuum Suction Unit	FSP480-121215	£523.00



- Suction Controller with Gauge
- Disposable Bacterial Filter
- Safety Overflow Valve
- Two Autoclavable Jars
- 1800ml capacity

FSP400-121215

Mobile High Vacuum Suction Unit

DESCRIPTION	PART No.	PRICE Ea.
Mobile High Vacuum Suction Unit	FSP400-121215	£431.00

SUCTION | INJECTOR SUCTION



FSR408-001516

- High Vacuum injector suction controller
- Gauge marked in kPa and mmHg
- Available with either disposable bacterial filter or silencer
- Remote probes fitted with 2m of Air tubing



FSR400-001216

Injector Suction Controller

With BS Air Probes and Tubing

DESCRIPTION	PART No.	PRICE Ea.
Injector Suction Controller, Disposable Filter on Rail Clamp and Remote BS Air Probe	FSR400-001216	£231.00
Injector Suction Controller, Disposable Filter on Direct BS Air Probe	FSR400-001516	£187.00
Injector Suction Controller, Disposable Filter and Bullnose Connector (3/8" BSP Thread)	FSR400-001525	£179.00
Injector Suction Controller on Male 'V' Wedge, Disposable Filter and Remote BS Air Probe	FSR400-001716	£210.00
Injector Suction Controller, Silencer on Rail Clamp and Remote BS Air Probe	FSR408-001216	£212.00
Injector Suction Controller, Silencer on Direct BS Air Probe	FSR408-001516	£189.00
Injector Suction Controller, Silencer and Bullnose Connector (3/8" BSP Thread)	FSR408-001525	£177.00
Injector Suction Controller on Male 'V' Wedge, Silencer and Remote BS Air Probe	FSR408-001716	£210.00

SUCTION | ELECTRIC SUCTION

Standard suction units are fitted with autoclavable polysulphone jar(s) –1800ml capacity + safety overflow valve. A disposable bacterial filter is fitted as standard (Hydrophobic filter can be fitted upon request). Alternative Jar and Liner systems are also available.



- Portable electric high vacuum suction unit, with one collection jar
- Maximum Vacuum: -83 kPa (623 mmHg)
- Suction Capacity: 26 l/min

FSE500-110019

Portable Electric High Suction

- 240V AC + Handle + Single Jar

DESCRIPTION	TYPE	PART No.	PRICE Ea.
Portable High Suction	Classic	FSE500-110019	£515.00
Portable High Suction	Premier	FSE500-111019	£562.00



- Portable electric high vacuum suction unit, with two collection jars
- Fitted with a change-over valve that enables the operator to switch from one jar to the other without interrupting suctioning
- Maximum Vacuum: -83 kPa (623 mmHg). Suction Capacity: 26 l/min

FSE550-111021

Portable Electric High Suction

- 240V AC + Handle + Two Jars

DESCRIPTION	TYPE	PART No.	PRICE Ea.
Portable High Suction	Classic	FSE550-111021	£578.00
Portable High Suction	Premier	FSE550-111021	£635.00

- Mobile electric high vacuum suction unit, mounted on a trolley
- Suitable for use in minor procedures
- Maximum Vacuum: -83 kPa (623 mmHg). Suction Capacity: 26 l/min



FSE570-120021

Mobile High Suction

- 240V AC + Handle + Two Jars

DESCRIPTION	TYPE	PART No.	PRICE Ea.
Portable High Suction	Classic	FSE570-120021	£677.00
Portable High Suction	Premier	FSE570-121021	£730.00



- Portable electric low vacuum suction unit, with one collection jar
- Suitable for abdominal and pleural drainage
- Maximum Vacuum: -20 kPa (150 mmHg). Suction Capacity: 4 l/min

FSE600-111033

Portable Electric Low Suction

- 240V AC + Handle + Single Jar

DESCRIPTION	TYPE	PART No.	PRICE Ea.
Portable Low Suction	Premier	FSE600-111033	£625.00



- Portable electric low vacuum suction unit, with one collection jar
- Features continuous and intermittent suctioning and is suitable for abdominal and pleural drainage
- Maximum Vacuum: -20 kPa (150 mmHg). Suction Capacity: 4 l/min

FSE650-110033

Portable Intermittent Low Suction

- 240V AC + Handle + Single Jar

DESCRIPTION	TYPE	PART No.	PRICE Ea.
Portable Low Suction	Classic	FSE650-110033	£935.00



- Portable emergency Battery/Mains high vacuum suction unit, with one collection jar
- Can be operated from the built-in battery, a 240V AC or 12V DC source
- Maximum Vacuum: -80 kPa (600 mmHg). Suction Capacity: 26 l/min

FSE450-110013

12V/240V Portable Electric High Suction

- 12V DC/240V AC + Single Jar

DESCRIPTION	PART No.	PRICE Ea.
12V/240V High Suction	FSE450-110013	£746.00

SUCTION | ELECTRIC SUCTION



FSE700-121027

Mobile Electric High Vacuum Theatre Suction Unit

With Two Collection Jars

DESCRIPTION	TYPE	PART No.	PRICE Ea.
Mobile Theatre Suction Unit	Classic	FSE700-120027	£1185.00
Mobile Theatre Suction Unit	Premier	FSE700-121027	£1395.00

- Mobile electric high vacuum suction unit with two lockable castors
- Suitable for use in the operating theatre
- Maximum Vacuum: -84 kPa (630 mmHg). Suction Capacity: 45 l/min

SUCTION | PORTABLE SUCTION



EPS101A

SAM e.p.s. Portable Suction Unit

With One Autoclavable Collection Jar and Spare Carrier

DESCRIPTION	PART No.	PRICE Ea.
SAM Portable Suction Unit with Autoclavable Jar	EPS101A	£798.00
SAM Portable Suction Unit with Serres Jar	EPS101S	£798.00
SAM Portable Suction Unit with VaxSax Jar	EPS101V	£798.00
SAM Portable Suction Unit with Serres Jar Neonatal	EPS101N	£1070.00

- Electric suction unit
- One Autoclavable 1000ml collection jar and gauge (marked in kPa and mmHg)
- Runs on either 12-28V DC, 100 – 240V AC
- Running Time: 120 Minutes on Full Power, Over 11 Hours on low settings
- Vacuum: 0 to 0.8 bar / 0 to 600 mmHg
- Flow Rate: Up to 32 l/min

- Rotating Bottle
- Unit can be used upright or flat
- Spare Carrier for larger, non-standard Jars
- On-board LED Lighting
- Comes with: Power Cable, Internal Charger, 1m Patient Tubing



EPS107

SAM e.p.s. Portable Suction Unit Accessories: SAM e.p.s. Portable Suction Unit Soft Case

DESCRIPTION	PART No.	PRICE Ea.
SAM Suction Unit Soft Case	EPS107	£65.50

- Allows full use of the Unit without removal
- Can be used with optional Carry Strap
- Durable and lightweight design



EPS108

SAM e.p.s. Portable Suction Unit Carry Strap

- 12V DC/240V AC + Single Jar

DESCRIPTION	PART No.	PRICE Ea.
SAM Suction Unit Carry Strap	EPS108	£19.95

- Easily clips to sides of Unit with, or without Soft Case fitted

SUCTION | PORTABLE SUCTION



EPS105

SAM e.p.s. Portable Suction Unit 12v Charging Plate

DESCRIPTION	PART No.	PRICE Ea.
SAM Portable Suction Unit Charging Plate 12/24V	EPS105	£153.75
SAM Portable Suction Unit Charging Plate 100/240V	EPS106	£153.75

- Wall Mounting Plate with 12v charging plug
- Unit easily clips onto Plate with or without Soft Case fitted



- Compact emergency foot operated suction unit
- One Autoclavable 1000ml collection jar and gauge (marked in kPa and mmHg)

FSF050-240000

Compact Emergency Foot/Hand Operated Suction Unit

With One Autoclavable Collection Jar

DESCRIPTION	PART No.	PRICE Ea.
1Ltr Foot/Hand Suction	FSF050-240000	£169.95



- High performance emergency foot operated suction unit
- One Autoclavable 1500ml collection jar, gauge (marked in kPa and mmHg) and vacuum adjustment knob

FSF100-110000

High Performance Emergency Foot/Hand Operated Suction Unit

With One Autoclavable Collection Jar

DESCRIPTION	PART No.	PRICE Ea.
1.5 Ltr Foot/Hand Suction	FSF100-110000	£259.95

AMBULANCE | MECORB® PIPELINE SYSTEMS



116192AMB

Assembled - Single

Terminal Units with Smoothflow Profiled Boxes

- Gas specific sockets with non-interchangeability
- Supplied with up to 7m of Hose and BS gas specific probe
- Complete with pipe clips and fixing screws
- First and Second Fix supplied
- Fully compliant with ISO 9170-1

GAS	PART No.	PRICE Ea.
O2	116191AMB	£75.00
O2/N2O	116192AMB	£75.00
N2O	116193AMB	£75.00
Air-7	116194AMB	£75.00
Air-4	116195AMB	£75.00
Vacuum	116196AMB	£75.00



116201AMB

Assembled - Twin

Terminal Units with Smoothflow Profiled Boxes

- Twin Gas specific sockets with non-interchangeability
- Supplied with up to 7m of Hose and BS gas specific probe
- Complete with pipe clips and fixing screws
- First and Second Fix supplied
- Fully compliant with ISO 9170-1

GAS	PART No.	PRICE Ea.
O2	116201AMB	£130.75
O2/N2O	116202AMB	£130.75
N2O	116203AMB	£130.75
Air-7	116204AMB	£130.75
Air-4	116205AMB	£130.75
Vacuum	116206AMB	£130.75



116191AN

Assembled - Single

Smoothflow Terminal Units

- Gas specific sockets with non-interchangeability
- Supplied with up to 7m of Hose and BS gas specific probe
- Complete with pipe clips and fixing screws
- First and Second Fix supplied
- Fully compliant with ISO 9170-1

GAS	PART No.	PRICE Ea.
O2	116191AN	£75.00
O2/N2O	116192AN	£75.00
N2O	116193AN	£75.00
Air-7	116194AN	£75.00
Air-4	116195AN	£75.00
Vacuum	116196AN	£75.00



116201AN

Assembled - Twin

Smoothflow Terminal Units

- Twin Gas specific sockets with non-interchangeability
- Supplied with up to 7m of Hose and BS gas specific probe
- Complete with pipe clips and fixing screws
- First and Second Fix supplied
- Fully compliant with ISO 9170-1

GAS	PART No.	PRICE Ea.
O2	116201AN	£130.75
O2/N2O	116202AN	£130.75
N2O	116203AN	£130.75
Air-7	116204AN	£130.75
Air-4	116205AN	£130.75
Vacuum	116206AN	£130.75

AMBULANCE | TERMINAL UNITS



202230/2TN

ORB Smoothflow Ambulance Terminal Unit (Square style)

- Gas specific sockets with non-interchangeability
- First Fix supplied with Hose Tail
- Complete with fixing screws to secure both First Fix and Box to base plate
- First and Second Fix supplied

GAS	PART No.	PRICE Ea.
O2	202230TN	£42.50
O2/N2O	202230/2TN	£42.50
N2O	202230/3TN	£42.50
Air-7	202230/4TN	£42.50
Air-4	202230/5TN	£42.50
Vacuum	202230/6TN	£42.50



202230AMB

ORB Smoothflow Ambulance Terminal Unit (Profiled style)

- Gas specific sockets with non-interchangeability
- First Fix supplied with Hose Tail
- Complete with fixing screws to secure both First Fix and Box to base plate
- First and Second Fix supplied

GAS	PART No.	PRICE Ea.
O2	202230AMB	£42.50
O2/N2O	2022302AMB	£42.50
N2O	2022303AMB	£42.50
Air-7	2022304AMB	£42.50
Air-4	2022305AMB	£42.50
Vacuum	2022306AMB	£42.50

AMBULANCE | TERMINAL UNITS



202230/6NN

ORB Smoothflow Ambulance Terminal Unit With Female NIST

- Gas specific sockets with non-interchangeability
- First Fix supplied with gas specific Female NIST
- Complete with fixing screws to secure both First Fix and Box to base plate
- First and Second Fix supplied

GAS	PART No.	PRICE Ea.
O2	202230NN	£44.75
O2/N2O	202230/2NN	£44.75
N2O	202230/3NN	£44.75
Air-7	202230/4NN	£44.75
Air-4	202230/5NN	£44.75
Vacuum	202230/6NN	£44.75



202230RAN

ORB Smoothflow Ambulance Terminal Unit With 90° Hose Tail Fitting

- Gas specific sockets with non-interchangeability
- First Fix supplied with Hose Tail
- Complete with fixing screws to secure both First Fix and Box to base plate
- First and Second Fix supplied

GAS	PART No.	PRICE Ea.
O2	202230RAN	£48.50
O2/N2O	202230/2RAN	£48.50
N2O	202230/3RAN	£48.50
Air-7	202230/4RAN	£48.50
Air-4	202230/5RAN	£48.50
Vacuum	202230/6RAN	£48.50

AMBULANCE | LOW PRESSURE WARNING PANEL



LPWP1

LPWP Series – Low Pressure Warning Panel

A warning system for use with two cylinders or single cylinder supply system. Designed to warn users of a drop in supply line pressure, alerting users to check the supply cylinder and switch to a new supply.

- Warning panel for when pipeline pressure is low
- Flush mounted fire retardant anti-microbial case
- Loud audible warning with LED indicator
- Separate mute button
- To be used with COVP manual change over unit or LPWB Low Pressure Warning Block
- Interface with vehicle information systems

DESCRIPTION	PART No.	PRICE Ea.
O2	LPWP1	£250.00
O2/N2O	LPWP2	£250.00
Air-4	LPWP5	£250.00

LPWB - Low Pressure Warning Block

- To be used with LPWP warning panel

DESCRIPTION	PART No.	PRICE Ea.
All gases	LPWB	£95.00



COVM1ST

COVM Series Manual Change Over Valve

- Manual change over between two cylinders
- Separate off position
- Fire retardant anti-microbial case and knob
- 0-11 Bar Pressure Gauge
- Choice of surface or rear entry gas connections

DESCRIPTION	PART No.	PRICE Ea.
O2 Surface Entry Hose Tails	COVM1ST	£225.00
O2/N2O Surface Entry Hose Tails	COVM2ST	£225.00
Air-4 Surface Entry Hose Tails	COVM5ST	£225.00
O2 Surface Entry NIST	COVM1SN	£250.00
O2/N2O Surface Entry NIST	COVM2SN	£250.00
Air-4 Surface Entry NIST	COVM5SN	£250.00
O2 Surface Entry DISS	COVM1SD	£250.00
Air Surface Entry DISS	COVM5SD	£250.00
O2 Rear Entry Hose Tails	COVM1RT	£225.00
O2/N2O Rear Entry Hose Tails	COVM2RT	£225.00
Air-4 Rear Entry Hose Tails	COVM5RT	£225.00
O2 Rear Entry NIST	COVM1RN	£250.00
O2/N2O Rear Entry NIST	COVM2RN	£250.00
Air-4 Rear Entry NIST	COVM5RN	£250.00
O2 Rear Entry DISS	COVM1RD	£250.00
Air Rear Entry DISS	COVM5RD	£250.00



COVP1ST

COVP Series Manual Change Over Valve – With Pressure Sensor

- Manual change over between two cylinders
- Separate off position
- Fire retardant anti-microbial case and knob
- 0-11 Bar Pressure Gauge
- Choice of surface or rear entry gas connections
- To be used with Low Pressure Warning Panel

DESCRIPTION	PART No.	PRICE Ea.
O2 Surface Entry Hose Tails	COVP1ST	£275.00
O2/N2O Surface Entry Hose Tails	COVP2ST	£275.00
Air-4 Surface Entry Hose Tails	COVP5ST	£275.00
O2 Surface Entry NIST	COVP1SN	£300.00
O2/N2O Surface Entry NIST	COVP2SN	£300.00
Air-4 Surface Entry NIST	COVP5SN	£300.00
O2 Surface Entry DISS	COVP1SD	£300.00
Air Surface Entry DISS	COVP5SD	£300.00
O2 Rear Entry Hose Tails	COVP1RT	£275.00
O2/N2O Rear Entry Hose Tails	COVP2RT	£275.00
Air-4 Rear Entry Hose Tails	COVP5RT	£275.00
O2 Rear Entry NIST	COVP1RN	£300.00
O2/N2O Rear Entry NIST	COVP2RN	£300.00
Air-4 Rear Entry NIST	COVP5RN	£300.00
O2 Rear Entry DISS	COVP1RD	£300.00
Air Rear Entry DISS	COVP5RD	£300.00



COVA1ST

COVA Series – Automatic Change Over Valve

For automatic switching between two gas cylinders to maximise use of gas contents in a safe and controlled way.

- Automatic switching between two cylinders with integral or detachable cylinders
- Clear display showing pipeline pressure
- Manual override switches to select cylinder
- Fire retardant anti-microbial case
- Loud audible warning with LED indicator
- Separate mute button
- Interface with vehicle information systems



DESCRIPTION	PART No.	PRICE Ea.
O2 Surface Entry Hose Tails	COVA1ST	£750.00
O2/N2O Surface Entry Hose Tails	COVA2ST	£750.00
Air-4 Surface Entry Hose Tails	COVA5ST	£750.00
O2 Surface Entry NIST	COVA1SN	£775.00
O2/N2O Surface Entry NIST	COVA2SN	£775.00
Air-4 Surface Entry NIST	COVA5SN	£775.00
O2 Surface Entry DISS	COVA1SD	£775.00
Air Surface Entry DISS	COVA5SD	£775.00

O2 Rear Entry Hose Tails	COVA1RT	£750.00
O2/N2O Rear Entry Hose Tails	COVA2RT	£750.00
Air-4 Rear Entry Hose Tails	COVA5RT	£750.00
O2 Rear Entry NIST	COVA1RN	£775.00
O2/N2O Rear Entry NIST	COVA2RN	£775.00
Air-4 Rear Entry NIST	COVA5RN	£775.00
O2 Rear Entry DISS	COVA1RD	£775.00
Air Rear Entry DISS	COVA5RD	£775.00

COVA1RP

COVA Series – Automatic Change Over Valve Remote Panel

- To be used with COVA Automatic Change Over Valve
- Flush mounted fire retardant anti-microbial case
- Duplicates information of the main unit through a wired connection
- Can be located in the patient compartment so is clear and visible

DESCRIPTION	PART No.	PRICE Ea.
O2 Remote Panel for COVA	COVA1RP	£250.00
O2/N2O Remote Panel for COVA	COVA2RP	£250.00
Air-4 Remote Panel for COVA	COVA5RP	£250.00



COVC1ST

COVC Series – Automatic Change Over Valve

For automatic switching between two gas cylinders, using cylinder pressure to maximise the use of gas contents in a safe and controlled way.

- Automatic switching between two cylinders fitted with detachable MEC regulators
- Clear display showing pipeline pressure and cylinder pressure
- Bar graph to indicate cylinder level
- Manual override switches to select cylinder
- Fire retardant anti-microbial case
- Loud audible warning with LED indicator
- Separate mute button
- MEC COVC regulators required
- Interface with vehicle information systems



DESCRIPTION	PART No.	PRICE Ea.
O2 Surface Entry Hose Tails	COVC1ST	£950.00
O2/N2O Surface Entry Hose Tails	COVC2ST	£950.00
Air-4 Surface Entry Hose Tails	COVC5ST	£950.00
O2 Surface Entry NIST	COVC1SN	£975.00
O2/N2O Surface Entry NIST	COVC2SN	£975.00
Air-4 Surface Entry NIST	COVC5SN	£975.00
O2 Surface Entry DISS	COVC1SD	£975.00
Air Surface Entry DISS	COVC5SD	£975.00
O2 Rear Entry Hose Tails	COVC1RT	£950.00
O2/N2O Rear Entry Hose Tails	COVC2RT	£950.00
Air-4 Rear Entry Hose Tails	COVC5RT	£950.00
O2 Rear Entry NIST	COVC1RN	£975.00
O2/N2O Rear Entry NIST	COVC2RN	£975.00
Air-4 Rear Entry NIST	COVC5RN	£975.00
O2 Rear Entry DISS	COVC1RD	£975.00
Air Rear Entry DISS	COVC5RD	£975.00

COVA1RP

COVC Series – Automatic Change Over Valve Remote Panel

- To be used with COVC Automatic Change Over Valve
- Flush mounted fire retardant anti-microbial case
- Duplicates information of the main unit through a wired connection
- Can be located in the patient compartment so is clear and visible

DESCRIPTION	PART No.	PRICE Ea.
O2 Remote Panel for COVC	COVC1RP	£250.00
O2/N2O Remote Panel for COVC	COVC2RP	£250.00
Air-4 Remote Panel for COVC	COVC5RP	£250.00



COVREGBN1

COVC Series – Regulators with Pressure Sensors

- Regulator with integrated Pressure Sensor
- 0-200 Bar

DESCRIPTION	PART No.	PRICE Ea.
O2 Bullnose	COVREGBN1	£299.00
Air-4 Bullnose	COVREGBN5	£299.00
O2 Pin Index	COVREGPI1	£299.00
O2/N2O Pin Index	COVREGPI2	£299.00
Air-4 Pin Index	COVREGPI5	£299.00

Other cylinder connections available



LPWGTB

LPWG Series – Low Pressure Warning Gauge

- Warning gauge for when pipeline pressure is low
- Fire retardant anti-microbial case
- 0-11 Bar Pressure Gauge
- Hose Tail and NIST connections available

DESCRIPTION	PART No.	PRICE Ea.
Tail – Bottom Entry	LPWGTB	£99.00
Tail – Top Entry	LPWGTT	£99.00
Tail – Left Entry	LPWGTL	£99.00
Tail – Right Entry	LPWGTR	£99.00
Tail – Rear Entry	LPWGTRR	£99.00
O2 NIST – Rear Entry	LPWG1NRR	£125.00
O2/N2O NIST – Rear Entry	LPWG2NRR	£125.00
Air-4 NIST – Rear Entry	LPWG5NRR	£125.00



116200

Basic Change Over Valve

- Universal change over valve without contents gauge
- 3 way lever to clearly marked positions: Cylinder 1, Cylinder 2 and Off

DESCRIPTION	PART No.	PRICE Ea.
Universal	116200	£89.95

DEMAND VALVES

- On demand Oxygen or 50/50 Nitrous Oxide/Oxygen (Entonox®) system
- Practical features to avoid cross contamination which provides a good patient experience
- Full length handle
- 2-4m hose with BS Schrader probe
- Can be used with generic filter systems

- Can be supplied with either a dedicated pressure regulator (as shown) or with any international hose fitting to use with your own cylinder or wall supply
- 5 Year Warranty
- 5 Year Service Interval
- 10 Year Intended Life-span
- Fully compliant with BS 4272-2



4961280

Entonox Demand Valve

DESCRIPTION	PART No.	PRICE Ea.
Entonox® Demand Valve (2M Hose)	4961280	£215.00
Entonox® Demand Valve (3M Hose)	4961281	£225.00
Entonox® Demand Valve (4M Hose)	4961282	£235.00



4961283

Entonox Demand Valve with Integral Regulator

DESCRIPTION	PART No.	PRICE Ea.
Entonox® Demand Valve with Integral Regulator (2M Hose)	4961283	£299.50



4961284

Oxygen Demand Valve

DESCRIPTION	PART No.	PRICE Ea.
Oxygen Demand Valve (2M Hose)	4961284	£215.00
Oxygen Demand Valve (3M Hose)	4961285	£225.00
Oxygen Demand Valve (4M Hose)	4961286	£235.00



4961287

Oxygen Demand Valve with Integral Regulator

DESCRIPTION	PART No.	PRICE Ea.
Oxygen Demand Valve with Integral Regulator (2M Hose)	4961287	£299.50

DESCRIPTION	PART No.	PRICE Ea.
AGSS Scavenging Adaptor	4961288	£49.00

GAS SPECIFIC SCHRADER | ADAPTERS

MEC provides a full range of Gas Specific Schrader adaptors for a permanent connection when it is required. Schrader adaptors have a non-interchangeability function and are available with a variety of thread and angled adaptors. Manufactured to ISO 9170-1.

- Gas specific connection with non-interchangeability
- Lightweight construction
- Designed for use with British Standard Probe connectors



19223

Single Adaptor

1/4" BSPT Thread (Male)

GAS	PART No.	PRICE Ea.
O2	19221	£35.95
O2/N2O	19222	£35.95
N2O	19223	£35.95
Air-7	19224	£35.95
Air-4	19225	£35.95
Vacuum	19226	£35.95



19326

Single Adaptor

1/8" BSPT Thread (Male)

GAS	PART No.	PRICE Ea.
O2	19321	£35.95
O2/N2O	19322	£35.95
N2O	19323	£35.95
Air-7	19324	£35.95
Air-4	19325	£35.95
Vacuum	19326	£35.95



19225SP

Single Adaptor

1/4" BSPT Thread (Female)

GAS	PART No.	PRICE Ea.
O2	19221SP	£35.95
O2/N2O	19222SP	£35.95
N2O	19223SP	£35.95
Air-7	19224SP	£35.95
Air-4	19225SP	£35.95
Vacuum	19226SP	£35.95



202291/2

Right Angled Adaptor

3/8" BSP Nut + Liner

GAS	PART No.	PRICE Ea.
O2	202291	£52.75
O2/N2O	202291/2	£52.75
N2O	202291/3	£52.75
Air-7	202291/4	£52.75
Air-4	202291/5	£52.75
Vacuum	202291/6	£52.75



191412/1

Straight Adaptor

3/8" BSP Nut + Liner

GAS	PART No.	PRICE Ea.
O2	191412/1	£52.75
O2/N2O	191412/2	£52.75
N2O	191412/3	£52.75
Air-7	191412/4	£52.75
Air-4	191412/5	£52.75
Vacuum	191412/6	£52.75



202316

Two Way Adaptor

3/8" BSP Nut + Liner - 3/8" BSP Male

GAS	PART No.	PRICE Ea.
O2	202311	£54.25
O2/N2O	202312	£54.25
N2O	202313	£54.25
Air-7	202314	£54.25
Air-4	202315	£54.25
Vacuum	202316	£54.25



19224TL

Single Adaptor and Hose Tail

GAS	PART No.	PRICE Ea.
O2	19221TL	£39.95
O2/N2O	19222TL	£39.95
N2O	19223TL	£39.95
Air-7	19224TL	£39.95
Air-4	19225TL	£39.95
Vacuum	19226TL	£39.95



3204987

Mini Schrader

1/8" BSP (Male) Coupling

GAS	PART No.	PRICE Ea.
O2	3204987	£38.25
Air-4	3204988	£38.25



1922TL/8 - External Threaded

Schrader Hose Tail

1/8" Male + Female Coupling

THREAD	PART No.	PRICE Ea.
Male	1922TL1/8	£11.25
Female	1922TL1/8F	£11.25



10700002T

Remote Mini Schrader Probe

GAS	PART No.	PRICE Ea.
O2	10700002T	£9.25
Air	1070000T5	£9.25



1922TL

Schrader Hose Tail

PART No.	PRICE Ea.
1922TL	£9.25



3204985

Mini Schrader Adaptor

+ BS Probe

GAS	PART No.	PRICE Ea.
O2	3204981	£89.00
Air-4	3204985	£89.00

MEC provides a full range of medical gas connectors with custom options available. We also stock international couplings.

GAS SPECIFIC SCHRADER | ADAPTERS

- Gas specific connection with non-interchangeability
- Lightweight construction
- Designed for use with British Standard Probe connectors



201904S

Straight Bar Twin Adaptor

50mm Back Bar - 3/8" BSP Nut + Liner

GAS	PART No.	PRICE Ea.
O2	201901S	£89.75
O2/N2O	201902S	£89.75
N2O	201903S	£89.75
Air-7	201904S	£89.75
Air-4	201905S	£89.75
Vacuum	201906S	£89.75



201902B

Straight Bar Twin Adaptor

50mm Back Bar - With BS Probe

GAS	PART No.	PRICE Ea.
O2	201901B	£99.75
O2/N2O	201902B	£99.75
N2O	201903B	£99.75
Air-7	201904B	£99.75
Air-4	201905B	£99.75
Vacuum	201906B	£99.75



201901NB

Straight Bar Twin Adaptor

50mm Back Bar - NIST

GAS	PART No.	PRICE Ea.
O2	201901NB	£99.75
O2/N2O	201902NB	£99.75
N2O	201903NB	£99.75
Air-7	201904NB	£99.75
Air-4	201905NB	£99.75
Vacuum	201906NB	£99.75



201906SL

Straight Bar Twin Adaptor

100mm Back Bar - 3/8" BSP Nut + Liner

GAS	PART No.	PRICE Ea.
O2	201901SL	£89.75
O2/N2O	201902SL	£89.75
N2O	201903SL	£89.75
Air-7	201904SL	£89.75
Air-4	201905SL	£89.75
Vacuum	201906SL	£89.75



201903BL

Straight Bar Twin Adaptor

100mm Back Bar - With BS Probe

GAS	PART No.	PRICE Ea.
O2	201901BL	£99.75
O2/N2O	201902BL	£99.75
N2O	201903BL	£99.75
Air-7	201904BL	£99.75
Air-4	201905BL	£99.75
Vacuum	201906BL	£99.75



201903NBL

Straight Bar Twin Adaptor

100mm Back Bar - NIST

GAS	PART No.	PRICE Ea.
O2	201901NBL	£99.75
O2/N2O	201902NBL	£99.75
N2O	201903NBL	£99.75
Air-7	201904NBL	£99.75
Air-4	201905NBL	£99.75
Vacuum	201906NBL	£99.75



201903

Twin Adaptor

Nut + Liner 3/8" BSP

GAS	PART No.	PRICE Ea.
O2	201901	£89.25
O2/N2O	201902	£89.25
N2O	201903	£89.25
Air-7	201904	£89.25
Air-4	201905	£89.25
Vacuum	201906	£89.25



201906P

Twin Adaptor + BS Probe

GAS	PART No.	PRICE Ea.
O2	201901P	£99.75
O2/N2O	201902P	£99.75
N2O	201903P	£99.75
Air-7	201904P	£99.75
Air-4	201905P	£99.75
Vacuum	201906P	£99.75



201901N

Twin Adaptor + NIST

GAS	PART No.	PRICE Ea.
O2	201901N	£99.75
O2/N2O	201902N	£99.75
N2O	201903N	£99.75
Air-7	201904N	£99.75
Air-4	201905N	£99.75
Vacuum	201906N	£99.75



3210281

Single Adaptor, Mini Schrader Adaptor

+ BS Probe

• Designed for use with British Standard / Mini Schrader Probe connectors

GAS	PART No.	PRICE Ea.
O2	3210281	£106.00
Air-4	3210285	£106.00



3204991

Twin Mini Schrader Adaptor

+ BS Probe

• Designed for use with Mini Schrader Probe connectors

GAS	PART No.	PRICE Ea.
O2	3204991	£106.00
Air-4	3204995	£106.00



3220000

O2 Mini Schrader

To Male plus Female NIST

• Designed for use with British Standard NIST connectors

GAS	PART No.	PRICE Ea.
O2	3220000	£115.25



Z0001/DIS/001

In Line Drain Trap Assembly

With Filter

GAS	PART No.	PRICE Ea.
O2 DISS	Z0001/DIS/001	£69.95
Air Diss	Z0005/DIS/001	£69.95
O2 NIST	Z0001/NIST/001	£69.95
Air-4 NIST	Z0005/NIST/001	£69.95

Fully automatic versions also available

PENDANTS | TERMINAL UNITS

The **MEC** Pendant Units are designed to fully comply with the requirements of ISO 9170-1. Features integral to the units include: non-interchangeability between probes, socket assembly terminal blocks, as well as quick release of the probe with single handed operation. The Pendants incorporate a secondary valve which facilitates ease of maintenance without interruption of the gas supply to the unit.



- 1m coloured gas specific anti-static hose
- British Standard NIST Probe + Nut
- British Standard gas specific pendant head
- (MRI version available, not as standard)
- Phthalate free
- Anti-Microbial

N68161H

Pendant Terminal Unit

+ 1m Hose Assembly

DESCRIPTION	PART No.	PRICE Ea.
O2	N68161H	£116.50
O2/N2O	N68162H	£116.50
N2O	N68163H	£116.50
Air-7	N68164H	£116.50
Air-4	N68165H	£116.50
Vacuum	N68166H	£116.50
AGSS	N231720H	£116.50

Alternative hose length may be specified at time of order



N68161

Pendant Terminal Unit

- British Standard gas specific pendant head
- (MRI version available, not as standard)

DESCRIPTION	PART No.	PRICE Ea.
O2	N68161	£69.75
O2/N2O	N68162	£69.75
N2O	N68163	£69.75
Air-7	N68164	£69.75
Air-4	N68165	£69.75
Vacuum	N68166	£69.75
AGSS	N231720	£69.75



163635

Ceiling Rose Pendant

- A combination of up to seven gases (six plus AGSS)
- Installation allowing complete flexibility
- 1m coloured gas specific anti-static hose
- (MRI version available, not as standard)
- Phthalate free
- Anti-Microbial

DESCRIPTION	PART No.	PRICE Ea.
One Gas	163631	£180.75
Two Gas	163632	£308.00
Three Gas	163633	£435.25
Four Gas	163634	£562.50
Five Gas	163635	£689.50
Six Gas	163636	£817.00
Seven Gas	163637	£944.00

Gas and hose length to be specified



(includes cover, not shown)

FPH6

Pendant Hose Assembly

1m

- 1m coloured gas specific anti-static hose
- British NIST Nut + NIST Probe Assembly
- British Standard gas specific female NIST
- MRI compatible
- Phthalate free
- Anti-Microbial

DESCRIPTION	PART No.	PRICE Ea.
O2	FPH1	£48.75
O2/N2O	FPH2	£48.75
N2O	FPH3	£48.75
Air-7	FPH4	£48.75
Air-4	FPH5	£48.75
Vacuum	FPH6	£48.75
AGSS	FPHAGSS	£48.75

Alternative hose length may be specified at time of order

FOR RE-HOSING WITH MEC PENDANT ONLY:

AGSS	231720HA	£48.75
------	----------	---------------

PENDANTS | SPLITTER UNIT



- Twin gas specific outlet points with Direct probe
- Mainly designed to be plugged into pendants
- Fully conforming with the requirements of European Standards ISO 9170-1

1920213

Pendant Splitter Unit

DESCRIPTION	PART No.	PRICE Ea.
O2	1920211	£139.75
O2/N2O	1920212	£139.75
N2O	1920213	£139.75



1920230

AGSS Splitter Unit

- Twin AGSS outlet points with probe

DESCRIPTION	PART No.	PRICE Ea.
AGSS	1920230	£250.00

ANAESTHETIC GAS SCAVENGING SYSTEMS

The AGSS is designed to conform to ISO 80601-2-13 and is used for the extraction of waste and excess gases, from the patient breathing system into the central anaesthetic gas scavenging disposal system. This is a device that safely collects and removes exhaled nitrous oxide and other anaesthetic gases during the administration of anaesthesia or sedation. The device is recommended by: AAGBI to avoid occupational exposure to the gases.



12800001P

AGSS Receiving Systems

DESCRIPTION	PART No.	PRICE Ea.
Receiving System inc. 3m Disposal Hose	12800001P	£485.00
Receiving System inc. 4m Disposal Hose	12800004	£487.50
Receiving System inc. 5m Disposal Hose	12800000	£489.50

- Conforms to current British Standard
- MRI compatible
- Wall, Rail or Machine mounted
- Weighs 1Kg, size 80mm X 390mm
- Supplied with Disposal and Transfer Hoses
- Both Disposal Hose and Patient Inlet port swivel about 360° to ensure hose positioning and prevent occlusion
- 3m, 4m or 5m Disposal Hose
- 2.4m Transfer Hose
- Complete with Pressure Relief Valve

Annual Service and Pre-planned Maintenance Contracts Available

PURAIR SCAVENGING SYSTEMS

MEC provides a range of Gas Stand Alone Scavenging Systems for a variety of applications. Each system differs in its extraction rate with flow capacity matched to the needs of a specific environment.



132200

Purair 130

- Cost effective method of Anaesthetic Gas Scavenging without the need for remote pipework
- Simple to install and factory set flow rates, so no commissioning is required
- Extraction capacity is 130 litres/min
- Conforms to ISO 80601-2-13 and is used for the extraction of waste and excess gases



750000

Purair 750 Maternity AGSS

- Designed specifically for maternity delivery suites where the patient is self-administered analgesia for pain relief
- Extraction capacity is 750 litres/min
- Effectively removes waste anaesthetic gas before it pollutes the working environment
- Secondary function is that of local extract ventilation (LEV)

DESCRIPTION	PART No.	PRICE Ea.
Purair 130 AGSS Kit	132200	£1125.00

DESCRIPTION	PART No.	PRICE Ea.
Purair 750 Maternity AGSS	750000	£2335.00
Purair 750 Birthing Pool	750000B	£2535.00



131800

Purair 80 AGSS

DESCRIPTION	PART No.	PRICE Ea.
Purair 80 AGSS	131800	£1550.00

- Designed as a stand alone scavenging unit for use with anaesthetic work stations that have an integrated patient air break
- Extraction capacity is 80 litres/min to current European flow rates
- Can be connected to a patient air break
- Occlusion and fault alarm

PERSONAL MONITORS

For staff exposure to waste anaesthetic gas: All prices include, hire of Personal Monitors, analysis after use (using the appropriate HSE recommended analysis method) and issue of a written report detailing the results compared against the relevant COSHH (Control Of Substances Hazardous to Health) Standards. **Anaesthetic Agents:** Choose from: Isoflurane, Enflurane, Halothane or Sevoflurane.

1613020

Gas Anaesthetic Agent Personal Monitor



DESCRIPTION	QUANTITY	PART No.	PRICE Ea.
x1 Gas AA Personal Monitor	1	1613020	£102.50
x1 Gas AA Personal Monitor	2	1613020	£97.50
x1 Gas AA Personal Monitor	3	1613020	£92.50
x1 Gas AA Personal Monitor	4	1613020	£87.50
x1 Gas AA Personal Monitor	5+	1613020	£79.50

DESCRIPTION	QUANTITY	PART No.	PRICE Ea.
x2 Gases AA Personal Monitor	1	1613030	£132.50
x2 Gases AA Personal Monitor	2	1613030	£127.50
x2 Gases AA Personal Monitor	3	1613030	£122.50
x2 Gases AA Personal Monitor	4	1613030	£117.50
x2 Gases AA Personal Monitor	5+	1613030	£109.50

DESCRIPTION	QUANTITY	PART No.	PRICE Ea.
x3 Gases AA Personal Monitor	1	1613040	£162.50
x3 Gases AA Personal Monitor	2	1613040	£157.50
x3 Gases AA Personal Monitor	3	1613040	£152.50
x3 Gases AA Personal Monitor	4	1613040	£147.50
x3 Gases AA Personal Monitor	5+	1613040	£139.50

1613010

Nitrous Oxide Personal Monitor



DESCRIPTION	QUANTITY	PART No.	PRICE Ea.
Nitrous Oxide Personal Monitor	1-4	1613010	£95.00
Nitrous Oxide Personal Monitor	5	1613010	£84.00

EQUIPMENT MOUNTING | BRACKETS

FRB202

Universal Rail Clamp

- Rail clamps for mounting onto equipment or for mounting equipment on to rail clamps
- Option of Female 'V' wall plate
- Anodised aluminium



DESCRIPTION	PART No.	PRICE Ea.
Universal Rail Clamp - for Mounting Equipment onto Rail Clamp	FRB202	£19.50
Universal Rail Clamp with Female 'V' Wall Plate Fitted	FRB212	£29.00

FRB210

Standard Universal Rail Clamp

19mm

- With clearance holes
- Anodised aluminium



DESCRIPTION	PART No.	PRICE Ea.
Standard Universal Rail Clamp - 19mm	FRB210	£9.50

FRB211

Standard Universal Rail Clamp

38mm

- With clearance holes
- Option of Female 'V' wall plate
- Anodised aluminium



DESCRIPTION	PART No.	PRICE Ea.
Standard Universal Rail Clamp - 38mm	FRB211	£10.50
Standard Universal Rail Clamp - 38mm With Female 'V' Wall Plate Fitted	FRB215	£19.50

FRB305

Pole Clamp

- Will accept poles 20mm to 40mm diameter
- Anodised aluminium



DESCRIPTION	PART No.	PRICE Ea.
Pole Clamp, x5 M5 Tapped Holes	FRB300	£32.50
Pole Clamp, x3 Countersunk Holes	FRB305	£34.50

FRB315

Bed Clamp

- For use on bed frames from 25mm to 50mm
- Anodised aluminium



DESCRIPTION	PART No.	PRICE Ea.
Bed Clamp, x5 M5 Tapped Holes	FRB310	£29.95
Bed Clamp, x3 Countersunk Holes	FRB315	£29.95

600601R

Cylinder Brackets

With Rail Clamp



DESCRIPTION	PART No.	PRICE Ea.
'C/D' Cylinder Bracket With Rail Clamp	600601R	£65.50
'E' Cylinder Bracket With Rail Clamp	600602R	£68.50

FRB205

Male 'V' Wedge/Wall Plate



DESCRIPTION	PART No.	PRICE Ea.
Male 'V' Wedge, x3 M5 Tapped Holes	FRB204	£8.50
Wall 'V' Plate, x2 Countersunk Holes	FRB205	£9.50
Male 'V' Wedge, x2 Diagonal Countersunk Holes	FRB206	£8.50
Male 'V' Wedge, x3 Countersunk Holes	FRB207	£8.50
Male 'V' Wedge, x2 M5 Diagonal Tapped Holes	FRB208	£8.50

FRB209

Female Slide Bracket



DESCRIPTION	PART No.	PRICE Ea.
Female Slide Bracket, Countersunk Holes	FRB209	£9.50



FRR510

- The MEC Universal Rail is an extruded aluminium section which fits directly to the wall, without additional distance pieces and fixing kits
- The Rail is suitable for both general and heavy-duty purposes
- Various Rail Clamps, including the DIN and Modura type fit this profile

Equipment Rails

DESCRIPTION	PART No.	PRICE Ea.
Universal Rail, 1m long with 2m Edge Trim, 1m Cover Strip, 3 Fixing Screws and Plugs and 2 End Caps	FRR510	£34.00
Universal Rail, 2m long with 4m Edge Trim, 2m Cover Strip, 5 Fixing Screws and Plugs and 2 End Caps	FRR520	£66.00
Universal Rail, 3m long with 6m Edge Trim, 3m Cover Strip, 8 Fixing Screws and Plugs and 2 End Caps	FRR530	£95.00

Rail Parts

- Complete set of parts for Railing Systems

DESCRIPTION	PART No.	PRICE Ea.
Universal Rail Trim - 1m	MER899	£1.50
Universal Rail Cover Strip - 1m	MER897	£1.25
Universal Rail End Cap (Pairs)	MEM751-2	£5.00
Universal Rail Trim - 1m, Without Trim and Cover Strip	MAI215	£19.25
5.5 75mm Countersunk Galvanised Wood Screw (Pack 10)	BLF881	£3.50
8mm Plastic Wall Plug (Pack 10)	BLF901	£0.95

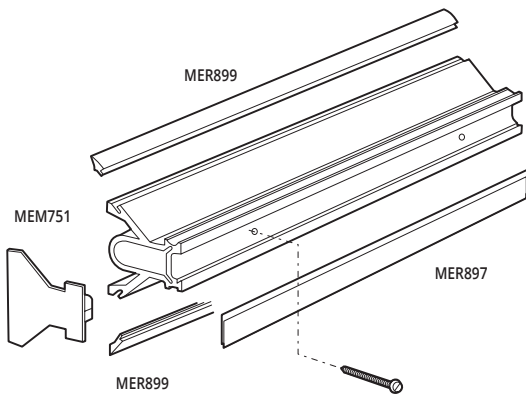

FCH911

Ceiling Mounted Drip Track

DESCRIPTION	PART No.	PRICE Ea.
Ceiling Mounted Drip Track - straight, 1m long with End Stops	FCH911	£16.50
Ceiling Mounted Drip Track - straight, 2m long with End Stops	FCH912	£25.50
Ceiling Mounted Drip Track - horseshoe shape, with Joining Piece and End Stops	FCH920	£67.50
Ceiling Mounted Drip Track - oval shape, with Joining Pieces	FCH930	£118.50

- Extruded aluminium section
- Straight, horseshoe and oval shapes



FCH750

Drip Track Runners and Joining Pieces

DESCRIPTION	PART No.	PRICE Ea.
Ceiling Track Runner with brake for Ceiling Mounted Drip Track	FCH750	£45.50
Ceiling Track Runner without brake for Ceiling Mounted Drip Track	FCH755	£22.50
Ceiling Track Joining Piece	FCH760	£7.50

- Fits Ceiling Mounted Drip Track
- With or without brakes
- Provides smooth operation



FCH100

Ceiling Mounted Drip Hangers

- Robust construction
- Lightweight
- Adaptable



FRM026-001200

Pole and Drip Hanger on Rail Clamp

- 1m long
- Anodised aluminium

DESCRIPTION	PART No.	PRICE Ea.
Ceiling Mounted Drip Hanger, 2 Drip Hooks Adjusted by Handscrew, 2.8m Ceiling Height	FCH100	£26.50
Ceiling Mounted Drip Hanger, 4 Drip Hooks Adjusted by Handscrew, 2.8m Ceiling Height	FCH200	£30.50
Ceiling Mounted Drip Hanger, 4 Drip Hooks Telescopic, 2.8m Ceiling Height	FCH400	£60.50
Ceiling Mounted Drip Hanger, 4 Drip Hooks Telescopic, 3.2m Ceiling Height	FCH410	£65.50
Ceiling Mounted Drip Hanger, 4 Drip Hooks Telescopic, 3.6m Ceiling Height	FCH420	£70.50
Ceiling Mounted Drip Hanger, 6 Drip Hooks Telescopic, 2.8m Ceiling Height	FCH600	£101.50
Ceiling Mounted Drip Hanger, 6 Drip Hooks Telescopic, 3.2m Ceiling Height	FCH610	£107.50
Ceiling Mounted Drip Hanger, 6 Drip Hooks Telescopic, 3.6m Ceiling Height	FCH620	£113.50

DESCRIPTION	PART No.	PRICE Ea.
Pole and Drip Hanger on Rail Clamp, 25mm Diameter, 2 Drip Hooks	FRM025-001200	£70.50
Pole and Drip Hanger on Rail Clamp, 25mm Diameter, 3 Drip Hooks	FRM026-001200	£72.50
Pole and Drip Hanger on Rail Clamp, 32mm Diameter, 2 Drip Hooks	FRM027-001200	£81.50
Pole and Drip Hanger on Rail Clamp, 32mm Diameter, 3 Drip Hooks	FRM028-001200	£83.50



FMD140

Mobile Drip Stand

Height Adjustable

- 5 strong castors
- Height adjustable from 1.1m to 1.93m



FRM035-001200

Pole and Drip Hanger on Rail Clamp

Height Adjustable

- 1m long
- Height adjustable
- Anodised aluminium

DESCRIPTION	PART No.	PRICE Ea.
Mobile Drip Stand, 2 Drip Hooks	FMD120	£107.50
Mobile Drip Stand, 3 Drip Hooks	FMD130	£109.50
Mobile Drip Stand, 4 Drip Hooks	FMD140	£111.50

DESCRIPTION	PART No.	PRICE Ea.
Drip Hanger on Rail Clamp, 2 Drip Hooks	FRM035-001200	£65.50
Drip Hanger on Rail Clamp, 3 Drip Hooks	FRM036-001200	£67.50

CYLINDER TROLLEYS AND BRACKETS



- Full range of Cylinder Trolleys available from sizes E to J
- Trolleys are finished in stove enamel
- Robust design with retaining bars or chains

TH8803

Cylinder Trolley

DESCRIPTION	PART No.	PRICE Ea.
'E' Size (24 cu ft)	TH8803	£129.50
'F' Size (48 cu ft)	TH8802	£156.50
'G' Size (120 cu ft)	TH8801	£172.50
'J' Size (240 cu ft)	TH8800	£256.50



600603

Premier Cylinder Trolleys

DESCRIPTION	PART No.	PRICE Ea.
'HX' Size	600603	£156.50
'J' Size (4 wheeled)	600605	£399.50



600601

Cylinder Brackets

DESCRIPTION	PART No.	PRICE Ea.
'C/D' Cylinder Metal Wall Bracket	600601	£49.50
'E' Cylinder Wall Bracket	600602	£53.50
Bed End 'C/D' Cradle	600607	£65.50



- Full range of Cylinder Rings available from sizes C to J
- Rings are fitted to the wall via a mating bracket
- Cylinder wall bracket available separately

TH8822

Cylinder Rings and Ring Bracket

DESCRIPTION	PART No.	PRICE Ea.
Cylinder Wall Bracket Only	TH8822	£40.00
'C' Size	TH8823	£45.00
'D/E' Size	TH8824	£45.00
'F' Size	TH8825	£45.00
'G' Size	TH8826	£45.00
'J' Size	TH8827	£45.00

MEDICAL CYLINDER CHART

The Table and Charts below give indications of cylinder size and types of valves generally used. The Pin Index valves show how the pins are arranged on the valves for each gas application.

	C	D	E	F	G	J
Oxygen	Pin Index	Pin Index	Pin Index	Bullnose	Bullnose	Pin Index
Nitrous Oxide	Pin Index	Pin Index	Pin Index	Handwheel	Handwheel	Handwheel
Entonox		Pin Index		Pin Index	Pin Index	
Air			Pin Index	Bullnose	Bullnose	Pin Index

Cylinder Types

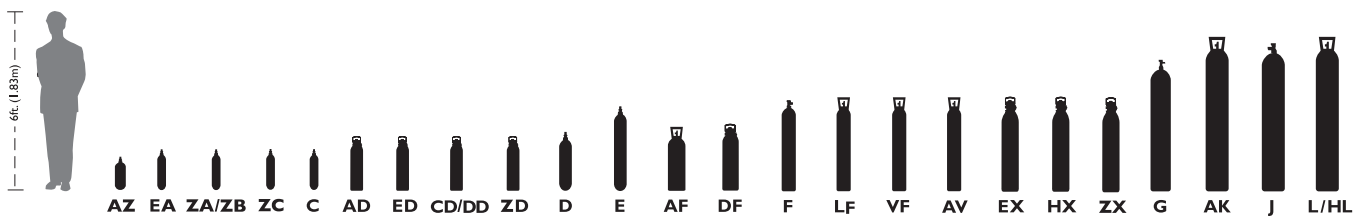

Valve Types

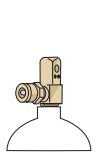

Pin-index Side Spindle valve



Integral valve

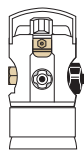

Handwheel valve



Bullnose valve

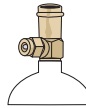

Pin-index valve



Handwheel side outlet

Pin Index Valves



Oxygen



Nitrous oxide



ENTONOX



Air



Carbon dioxide

EMERGENCY KITS



Other cylinder connections available

EKS2UN

Universal Emergency Kit

DESCRIPTION	PART No.	PRICE Ea.
O2	EKS2UN	£1250.00
Air-4	EKS2AUN	£1250.00
Air-7	EKS2A7UN	£1250.00
N2O - Handwheel	EKS2N2ON	£1200.00
O2/N2O	EKS2MIXN	£1300.00

300 Bar Backfeed Emergency Kits ISO 5145

O2	ESK2N5	£1400.00
O2/N2O	ESK2MIXN13	£1400.00

- All components gas specific to BS 5682
- Quick action couplings enable a fuss free change-over to be completed in minimum time
- One kit will serve two cylinders
- 2 x Two Stage Bullnose Regulators with right angle adaptors
- 2 x Splitter Hose Assembly
- 1 x Splitter Unit
- 1 x Pendant Hose Assembly
- 1 Emergency Kit Box
- 2 x Pin Index Adaptors
- Combination Spanner
- Cylinder Key

CHANGE OVER VALVE HOSE ASSEMBLY

116405

Change Over Valve Hose Assembly

Change Over Valve Hose Assembly BS Probe

- 1 metre assemblies
- British Standard remote probes
- BS Probe



GAS	PART No.	PRICE Ea.
O2	116401	£149.50
O2/N2O	116402	£149.50
N2O	116403	£149.50
Air-7	116404	£149.50
Air-4	116405	£149.50

116403N

Change Over Valve Hose Assembly

Change Over Valve Hose Assembly
NIST Probe + NIST Nut

- 1 metre assemblies
- British Standard remote probes
- NIST Probe + NIST Nut



GAS	PART No.	PRICE Ea.
O2	116401N	£149.50
O2/N2O	116402N	£149.50
N2O	116403N	£149.50
Air-7	116404N	£149.50
Air-4	116405N	£149.50

TEST EQUIPMENT

MEC Test Equipment allows you to regularly check that medical gas pipelines are operating correctly to HTM02-01 guidelines. A comprehensive range of sets are available to test and calibrate medical gas pressure, flow and vacuum, ensure terminal units are gas specific and that active anaesthetic gas scavenging systems are adjusted to provide optimal performance. Particulate matter testing with purging allows checking for particulate contamination within the pipeline as well as purging from terminal unit or NIST points. Included in the range are dew point meters to identify contamination of pipeline systems by moisture.

- Two Pressure Guns to measure all eight pressure gases
- Third Gun to check vacuum
- Designed to check and calibrate British Standard Terminal Units for safe pressure and flow rates
- In compliance with HTM02-01 and relevant European Standards and all preceding standards
- Strong and sturdy Peli Box Case



2005NP

Pressure and Flow Medical Gas Test Kit

DESCRIPTION	PART No.	PRICE Ea.
Pressure and Flow Medical Gas Test Set	2005NP	£2750.00

- Two Pressure Guns to measure all seven pressure gases
- Third Gun to check vacuum
- Designed to check and calibrate British Standard Terminal Units for safe pressure and flow rates
- Additional test probes can be purchased to test alternative outlet types
- In compliance with HTM02-01 and relevant European Standards and all preceding standards



2005ND

Digital Pressure and Flow Medical Gas Test Set

DESCRIPTION	PART No.	PRICE Ea.
Digital Pressure and Flow Medical Gas Test Set	2005ND	£3250.00

Upgrade Kit

DESCRIPTION	PART No.	PRICE Ea.
Upgrade with Peli Box	205700UP	£995.00

205700UP

- Pressure Gun to Update MEC Medical Two Gun Test Set
- In compliance with HTM02-01 and relevant European Standards and all preceding standards
- Includes: Pressure Gun, Nitric Oxide Probe and replacement box

- A complete set all in one box to carry out Test and Commissioning
- Includes Pressure and Flow, AGSS Test and Commissioning, Male Anti Confusion NIST, Anti Confusion Probes and Standard Purging test kits
- In compliance with HTM02-01 and relevant European Standards and all preceding standards



2004T

Medical Gas Test and Commissioning Kit

DESCRIPTION	PART No.	PRICE Ea.
Medical Gas Test and Commissioning Kit	2004	£4795.00
As above with additional purpose-built Trolley	2004T	£4995.00

- A complete set all in one box to carry out Test and Commissioning
- Includes Pressure and Flow, AGSS Test and Commissioning, Male Anti Confusion NIST, Anti Confusion Probes and Standard Purging test kits
- In compliance with HTM02-01 and relevant European Standards and all preceding standards



2004DT

Digital Medical Gas Test and Commissioning Kit

DESCRIPTION	PART No.	PRICE Ea.
Digital Medical Gas Test and Commissioning Kit	2004D	£5995.00
As above with additional purpose-built Trolley	2004DT	£6295.00

TEST EQUIPMENT

- Set of six stainless steel gas specific probes
- Gases include O₂, O₂/N₂O, N₂O, Air-4 Bar, Air-7 Bar, Vacuum
- Calibrated to BS 5682
- In compliance with HTM02-01 and relevant European Standards and all preceding standards



20160

Anti Confusion Probes

DESCRIPTION	PART No.	PRICE Ea.
Anti Confusion Probes	20160	£295.00

- Allows performance testing of six AGSS outlet points to BS 6834
- 0-20 Bar Manometer included
- Flow gauge, with adjusting tool and Allen Key
- In compliance with HTM02-01 and relevant European Standards and all preceding standards



19031100

AGSS Test and Commissioning Set

DESCRIPTION	PART No.	PRICE Ea.
AGSS Test and Commissioning Set	19031100	£2250.00

- Set of six stainless steel gas specific probes
- Gases include O₂, O₂/N₂O, N₂O, Air-4 Bar, Air-7 Bar, Vacuum
- Calibrated to BS 5682
- In compliance with HTM02-01 and relevant European Standards and all preceding standards



20170N

Female NIST Anti Confusion Test Set

DESCRIPTION	PART No.	PRICE Ea.
NIST Anti Confusion Test Set	20170N	£295.00

- Set of six or nine stainless steel gas specific NIST probes
- Gases include O₂, O₂/N₂O, N₂O, Air-4 Bar, Air-7 Bar, Vacuum
- Nine includes CO₂, N, HEO₂ (Carbon Dioxide, Nitrogen, Heliox)
- Calibrated and manufactured to current industry standards
- In compliance with HTM02-01 and relevant European Standards and all preceding standards



20170-9

Male NIST Anti Confusion Probes

DESCRIPTION	PART No.	PRICE Ea.
Male NIST Anti Confusion Probes x6	20170	£295.00
Male NIST Anti Confusion Probes x9	20170-9	£430.00

AEROALPHA

Aerotest Alpha Breathing Monitor

Monitor For Breathing Air Purity



DESCRIPTION	PART No.	PRICE Ea.
Aerotest Alpha Breathing Monitor	AEROALPHA	£1950.00

- All the necessary components in a single system
- Concentrations can be determined either individually or simultaneously
- In compliance with EN12-021 and relevant European Standards
- All components are housed ready for use in a handy carrying case
- Quick and easy to apply. In just five minutes, the Quick-Check indicates measurement results and provides information about the degree of contamination

TEST EQUIPMENT

- Polycarbonate filter holder 47mm
- 75/150Lpm flow rate jets
- Hydrophobic Membrane 47mm filter papers, 0.45(µm) pore size
- In compliance with HTM02-01 and relevant European Standards and all preceding standards



2002

Standard Particulate and Purging Kit

Standard Test Set

DESCRIPTION	PART No.	PRICE Ea.
Particulate and Purging Kit	2002	£895.00

- Stainless steel filter holder 47mm
- 75/150Lpm flow rate jets
- Hydrophobic Membrane 47mm filter papers, 0.45(µm) pore size
- NIST and Terminal Unit connectivity
- In compliance with HTM02-01 and relevant European Standards and all preceding standards



2001

Particulate and Purging Medical Gas Test Kit

Standard Test Set

DESCRIPTION	PART No.	PRICE Ea.
Particulate and Purging Kit	2001	£1995.00

- 1, 2 and 4 kPa Orifices
- Meets current industry standard
- Flow gauge with AGSS hose and probe for connectivity allowing for basic flow rate tests to BS 6834
- In compliance with HTM02-01 and relevant European Standards and all preceding standards



232005

AGSS Flow Rate Test Set

DESCRIPTION	PART No.	PRICE Ea.
AGSS Flow Rate Test Set	232005	£495.00

- A kit designed for test and commissioning of ambulance pipeline systems
- 0-10.5 Bar Pre Set Two Stage Regulator
- HTM02-01 Pressure Gun
- Test probes O2 and O2/N2O
- In compliance with HTM02-01 and relevant European Standards and all preceding standards



116205

Vehicle Pressure and Flow Test Set

DESCRIPTION	PART No.	PRICE Ea.
Vehicle Pressure and Flow Test Set	116205	£1065.00

200011

Pressure Drop Test Gun

Plus choice of Digital or Analogue Pressure Gauge



DESCRIPTION	PART No.	PRICE Ea.
Pressure Drop Test Gun (Digital Gauge) NIST	200011D	£470.00
Pressure Drop Test Gun (Analogue Gauge) NIST	200011	£92.50
Pressure Drop Test Gun (Digital Gauge) Probe	200011DP	£470.00
Pressure Drop Test Gun (Analogue Gauge) Probe	200011P	£92.50

- Measures pressure losses at NIST or Outlet Point
- Lockable valve to prevent tampering
- Ideal to test at AVSU and Manifold points
- 20054D Digital Pressure Gauge or Conventional Analogue Gauge

TEST EQUIPMENT

- For measuring pressure losses at either NIST or Outlet Point
- Lockable valve to prevent tampering
- Ideal to test at AVSU and Manifold points



2010

Standard Pressure Drop Test Kit

DESCRIPTION	PART No.	PRICE Ea.
Pressure Drop Test Kit with NIST Connections	2010	£425.00
Pressure Drop Test Kit with Probe Connections	2010P	£425.00

- For measuring pressure losses at either NIST or Outlet Point
- Lockable valve to prevent tampering
- Ideal to test at AVSU and Manifold points
- One or two 20054D Digital Pressure Gauge(s)



2011

Pressure Drop Test Kit

Plus choice of 1 or 2 Digital Pressure Gauge(s)

DESCRIPTION	PART No.	PRICE Ea.
Pressure Drop Test Kit (x1 Digital Gauge) NIST	2011	£825.00
Pressure Drop Test Kit (x2 Digital Gauges) NIST	2012	£1200.00
Pressure Drop Test Kit (x1 Digital Gauge) Probe	2011P	£825.00
Pressure Drop Test Kit (x2 Digital Gauges) Probe	2012P	£1200.00

- Designed to Pressure test up to 6 pendant hoses at once
- -1 – 30 Bar Digital Pressure Gauge installed on manifold
- 10 Bar Pressure Regulator
- Test hose to connect to Manifold from Regulator
- Non gas specific NIST's allowing any Pressure Gas or Vacuum hose to be connected
- Test certificate included



200850

Hose Pressure Test Rig

DESCRIPTION	PART No.	PRICE Ea.
Hose Pressure Test Rig	200850	£1995.00

New CO2 analyser specifically designed to monitor CO2 for the verification of incubators in research and pharmaceutical markets. Developed to be fast, simple to use and accurate.

- Improved accuracy on CO2 readings
- Quick verification of CO2 incubator levels
- Time saving dual temperature probes
- Built-in gas moisture removal
- CO2 0-20%, O2 0-100%
- Dual temperature probes 0 to 50°C
- Humidity sensor 0-100%
- Large data storage and user friendly software and download



G100ANZ

Medi Gas Check G100

CO2 Incubator Analyser

DESCRIPTION	PART No.	PRICE Ea.
G100 Medi Gas Check	G100ANZ	£1595.00
Plus O2 Sensor	G100ANZ-O2	£1695.00

MEC Test Equipment demonstration videos available at mecmedical.com

TEST EQUIPMENT

Specifically designed for accurate measurement and verification of piped N2O, O2 and contaminants in hospitals. Measures four gases, N2O, O2, CO and CO2 within one analyser. Portable and user friendly.

- Easy user calibration
- Quick verification of gas quality
- User alarms
- Data storage with site and ID input
- Identify contamination with CO and CO2



G210ANZ

G210 Gas Analyser

Accurate quality assessment of N2O, O2, CO and CO2

DESCRIPTION	PART No.	PRICE Ea.
G210 Gas Analyser	G210ANZ	£4195.00
Analyser Regulator Kit incl. Gas Specific Probes	G210REG	£650.00
G210 Gas Analyser Calibration Kit	G210CAL	£485.00
G210 Software Package	G210DATA	£305.00
Carry Case	G210CASE	£100.00

G200 Gas Analyser for the accurate quality assessment of N2O. Cost effective monitor, easy to use portable system for dental departments or professionals using anaesthetic gases and surgeries.

- 0-1,000 ppm N2O
- Storage for 1,000 readings
- TWA calculated
- Leak detection
- Calculates EH40 occupational exposure limits
- Data download for graphing and reporting



G200ANZ

G200 Gas Analyser

Accurate quality assessment of N2O

DESCRIPTION	PART No.	PRICE Ea.
G200 Gas Analyser	G200ANZ	£2150.00
G200 Software Package	G200DATA	£295.00
Carry Case	G200CASE	£100.00

Instrument for testing medical, surgical and breathing-air systems (HTM02-01, Pharmacopeia and EN12021) up to 10 bar. Built-in electronic dewpoint meter, electrochemical oxygen cell and digital flowmeter. Tests CO, CO2, NOX, SO2, H2S and Polytest using Draeger chemical reagent tubes and oil using the Impactor. Colour touch screen menu driven display and rechargeable batteries. The unit also has a battery tray which accommodates 6 AA alkaline type batteries. In the event that the rechargeable batteries are not sufficiently recharged then you can continue to use the instrument with either the alkaline batteries or a mains power supply. Built in memory, downloadable to PC safe-air tester results software. Supplied as standard in PELI carrying case, also provided with:

- Duracell (AA) alkaline batteries
- Universal mains power adapter
- USB tester results download cable
- F2193 connection adaptor with CEJN plug
- Tube tip cutter
- Travel container
- Operating Manual



F4504

Multi-Air Tester

DESCRIPTION	PART No.	PRICE Ea.
Multi-Air Tester	F4504	£6650.00
20 Bar Regulator	F3005	£155.00

These cost effective detector tubes are able to offer quick, on the spot measurements of many gases and vapours using the manual pump.

- Accurate and reliable results
- Simple method of oil detection without the need of calibration
- Measurement of oil content and impurities in medical gases
- Compatible with all syringe type pumps
- In compliance with HTM02-01 and relevant European Standards and all preceding standards



DETPUMP

Gas Detection Tubes and Pump

For the detection of oils and impurities in medical gas

DESCRIPTION	PART No.	PRICE Ea.
Gas Detection Syringe Pump	DETPUMP	£299.00
GAS DETECTION TUBES		
CO	DETCO	£69.95
CO2	DETCO2	£69.95
H2O	DETH2O	£69.95
NO	DETNEX	£69.95
SO2	DETSO2	£69.95

TEST EQUIPMENT

The Medi-Gas Check Medi-Qube is supplied in two forms, one for use with Oxygen (O2) and is therefore O2 clean and another for Medical and Surgical Air and other non-flammable medical gases. Only the Medi-Gas Check Medi-Qube for O2 must be used with O2.

- Fast, accurate and reliable results
- Quickest method of oil detection
- Measurement of oil content and impurities in medical gases
- Calibrated for use with Draeger polytest detector tubes and the new oil impactor



MEDI-QUBE

Medi-Qube

For the detection of oils and impurities in medical gas

DESCRIPTION	PART No.	PRICE Ea.
Medi-Qube (All Gases EXCEPT O2)	MEDI-QUBE	£845.00
Medi-Qube (O2 ONLY)	MEDI-QUBE02	£945.00
Poly Test Oil Impactors	DETPOLY	£99.00



SERVOMEX

SERVOMEX MiniHD (5200)

Rugged Portable Gas Analyser

DESCRIPTION	PART No.	PRICE Ea.
SERVOMEX MiniHD (5200) Rugged Portable Gas Analyser	SERVOMEX	£5995.00
SERVOMEX Case	SERVO-CASE	£450.00
SERVOMEX Bag	SERVO-BAG	£125.00

- Compact, reliable and easy to use with long life and minimal running costs
- Non-depleting paramagnetic or infrared measurement technology ensures the unit is always ready for use
- Fast, accurate, reliable and component specific, with confidence that observed values are credible and not due to background interference
- Robust, IP65 case with protective overmoulding
- Customer pre-tested software and long life Li-ion rechargeable batteries for maximum ease of use
- Two versions available: Internally pumped or "AFCD" version for pressurised samples
- Avoids the problems associated with electrochemical or other less robust methods of analysis

- Repeatedly fast measurements at low pressure from less than 15 minutes for t95 to -60°C
- Higher pressure measurements possible – up to 350 bar
- Long battery life: up to 48 hours of typical use between charges
- Intuitive application kits allow quick and straightforward connection to your sample point
- Durable, yet easy to handle and operate: designed for use in industrial environments
- 4-20mA external device input for transmitter calibration and validation
- Lightweight: less than 1.5kg
- 13 point traceable calibration certificate



DEWP2

MDM 300

Advanced Dew-point Hygrometer

DESCRIPTION	PART No.	PRICE Ea.
Advanced Dew-point Hygrometer	DEWP2	£3495.00
Advanced Dew-point Easi Fit Sampling Kit	DEWPMSPL	£950.00

- Wide measurement range
- Simple operation
- Integral sampling system
- Rugged industrial case
- ±2°Cdp accuracy
- Traceable to National Standards
- Powered by rechargeable battery
- Lowest cost of ownership due to minimal maintenance



DEWP

Easidew Portable

Easidew Portable Dew-point Hygrometer

DESCRIPTION	PART No.	PRICE Ea.
Easidew Portable Dew-point Hygrometer	DEWP	£2500.00

TEST EQUIPMENT



20054D

Digital Pressure Gauge

DESCRIPTION	PART No.	PRICE Ea.
Gauge	20054D	£435.00
Rubber Boot	20054DB	£17.50
Case	20054DC	£32.50
Universal Probe with 7/16"-20 UNF	007916UNF	£55.50

- -1 to 30 bar pressure range
- Accuracy RT (room temperature) <0.1% FS
- Total Error Band (0...50°C) <0.2% FS
- 1000 hours continuous operation
- Pressure connection 7/16"-20 UNF (1/4" adaptor included)



29000

Pneumatic Hand Pump Kit

Pressure/vacuum levels (small volumes)

DESCRIPTION	PART No.	PRICE Ea.
Pneumatic Hand Pump Kit	29000	£995.00

- With 3/8" BSP Parallel Female Connection
- A portable dual source of vacuum and pressure
- Volume control for fine adjustment
- Adjustable stroke for varying maximum pressure output (pressure protection)
- Quick fit connectors
- BSP or NPT adaptor set
- Full seal kit supplied



119901

Rechargeable Crimping Tool

With Carrying Case, 240V Charger and 18V Li-ion Battery

DESCRIPTION	PART No.	PRICE Ea.
Crimping Tool	119901	£2150.00

- Easy to use
- For use with Ferrule 4131
- Supplied with MEC jaw set
- Certified suitable for manufacturing a compliant crimp when used with MEC hose and hose components
- Battery condition indicator
- One handed operation and release
- Head rotates for ease of access
- Tested to requirements of ISO 5359

TEST EQUIPMENT ACCESSORIES AND SPARES



24820012/10

British Standard Universal Probes

With Flow Rate Jets

MEC provides a range of calibrated Flow Rate test probes for checking flow rates of Terminal Units to current British Standards to meet the needs and requirements of HTM02-01.

- Stainless steel one piece probes
- Calibrated jets
- Engraved body with flow rate and outlet pressure
- Jets set at 400kPa (350LPM Jet set at 700kPa)

DESCRIPTION	PART No.	PRICE Ea.
10LPM Jet	24820012/10	£59.95
15LPM Jet	24820012/15	£59.95
20LPM Jet	24820012/20	£59.95
40LPM Jet	24820012/40	£59.95
50LPM Jet	24820012/50	£59.95
80LPM Jet	24820012/80	£59.95
100LPM Jet	24820012/100	£59.95
150LPM Jet	24820012/150	£59.95
200LPM Jet	24820012/200	£59.95
350LPM Jet	24820012/350	£59.95



007

Remote Universal Probe Body

PART No.	PRICE Ea.
007	£6.75

- Strictly for test purposes only



248

Direct Universal Probe Body

3/8" BSP Male

PART No.	PRICE Ea.
248	£7.75

- Strictly for test purposes only



1414

NIST Nut

Non Gas Specific (NGS)

PART No.	PRICE Ea.
1414	£7.00

- Strictly for test purposes only



1416NGS

NIST Probe with 'O' Ring

Non Gas Specific (NGS)

PART No.	PRICE Ea.
1416NGS	£8.00

- Strictly for test purposes only



161717/1

Leak Detection Unit

GAS	PART No.	PRICE Ea.
O2	161717/1	£125.75
O2/N2O	161717/2	£125.75
N2O	161717/3	£125.75
Air-7	161717/4	£125.75
Air-4	161717/5	£125.75

- Gas specific connection with non-interchangeability
- Lightweight construction
- Designed for use with British Standard Probe connectors
- On/Off Pressure Valve
- 0-11 Bar Pressure Gauge

MEC provides a full range of test equipment to test medical gas pipeline systems to HTM 02-01 and ISO standards.

TEST EQUIPMENT RECALIBRATION



DESCRIPTION	PART No.	PRICE Ea.
Anti-Confusion Test Probes	RECALCON	£49.75
Anti-Confusion NISTs	RECALACN	£49.75
Anti-Confusion NIST Test Set	RECALACNF	£49.75
AGSS Flow Rate Test Set	RECALDIS	£74.75
AGSS Test and Commissioning Set	RECALCOM	£218.50
Test Set for Pressure and Flow (Includes internal valve seals and 'O' Rings + Gauges + Probes)	RECAL3	£218.50
Digital Test Set for Pressure and Flow (Includes internal valve seals and 'O' Rings + Probes)	RECAL3D	£218.50
Medical Gas Test and Commissioning Kit	RECAL4	£450.00
Digital Medical Gas Test and Commissioning Kit	RECAL4D	£450.00
Pressure Drop Test Kit NIST	RECALPDK (NIST)	£99.95
Pressure Drop Test Kit Probe	RECALPDKP (Probe)	£99.95
Pressure Drop Test Kit NIST plus 1 Digital Gauge	RECALPDK1 (NIST)	£189.00
Pressure Drop Test Kit Probe plus 1 Digital Gauge	RECALPDKP1 (Probe)	£189.00
Pressure Drop Test Kit NIST plus 2 Digital Gauges	RECALPDK2 (NIST)	£249.00
Pressure Drop Test Kit Probe plus 2 Digital Gauges	RECALPDKP2 (Probe)	£249.00
Vehicle Pressure and Flow Set	RECALVEH	£77.00
Standard Particulate and Purging Kit	RECALPURG	£49.00
G210 Gas Analyser	RECALG210	£550.00
G200 Gas Analyser	RECALG200	£450.00

EMERGENCY KIT SERVICING

Annual Service

- Includes full test and inspect
- Replacement Seal and 'O' Rings

3-5 Year Service

- Includes full test and inspect
- Replacement Seal and 'O' Rings
- Replacement Hoses and Cartridge Assemblies
- New Labels

DESCRIPTION	PART No.	PRICE Ea.
Emergency Kit Service Annual Service	EKS2YR	£150.00
Emergency Kit Service 3-5 Year Service	EKS2SERV	£250.00

SCAVENGING PLANT | SINGLE PHASE

- Fully Compliant to HTM 02-01
- Inlet and Exhaust supplied with flexible coupling and copper pipeline connectors
- Anti-vibration mounts fitted to pump units
- Pre-set vacuum balance valve and pressure sensor
- Highly visible condensate drain flask fitted to exhaust
- Fully tested and certified prior to despatch
- Alarm or BSM output module optional extra



GSS260/1/24

Simplex Plant

Single Phase 240V 50Hz

PART No.	PRICE Ea.
GSS260/1/24	£1155.00
GSS520/1/24	£1512.00
GSS1040/1/24	£1596.00

- Fully Compliant to HTM 02-01
- Inlet and Exhaust supplied with flexible coupling and copper pipeline connectors
- Anti-vibration mounts fitted to pump units
- Pre-set vacuum balance valve and pressure sensor
- Highly visible condensate drain flask fitted to exhaust
- Fully tested and certified prior to despatch
- Alarm or BSM output module optional extra
- Available in multiple configurations including "stacked" Duplex AGSS



GSD260/1/24

Duplex Plant

Single Phase 240V 50Hz

PART No.	PRICE Ea.
GSD260/1/24	£2799.00
GSD520/1/24	£3992.00
GSD1040/1/24	£4220.00

SCAVENGING PLANT | THREE PHASE

- Fully Compliant to HTM 02-01
- Inlet and Exhaust supplied with flexible coupling and copper pipeline connectors
- Anti-vibration mounts fitted to pump units
- Pre-set vacuum balance valve and pressure sensor
- Highly visible condensate drain flask fitted to exhaust
- Fully tested and certified prior to despatch
- Alarm or BSM output module optional extra



GSS260/3/24

Simplex Plant

Three Phase 415V 50Hz

PART No.	PRICE Ea.
GSS260/3/24	£1092.00
GSS520/3/24	£1392.00
GSS1040/3/24	£1463.00
GSS1430/3/24	£1770.00
GSS1820/3/24	£1945.00
GSS2600/3/24	£2113.00
GSS3770/3/24	£2316.00

- Fully Compliant to HTM 02-01
- Inlet and Exhaust supplied with flexible coupling and copper pipeline connectors
- Anti-vibration mounts fitted to pump units
- Pre-set vacuum balance valve and pressure sensor
- Highly visible condensate drain flask fitted to exhaust
- Fully tested and certified prior to despatch
- Alarm or BSM output module optional extra
- Available in multiple configurations including "stacked" Duplex AGSS



GSD260/3/24

Duplex Plant

Three Phase 415V 50Hz

PART No.	PRICE Ea.
GSD260/3/24	£2520.00
GSD520/3/24	£3213.00
GSD1040/3/24	£3586.00
GSD1430/3/24	£4121.00
GSD1820/3/24	£4303.00
GSD2600/3/24	£4954.00
GSD3770/3/24	£5431.00



Air Plant

MEC provides a full range of Air plant systems from Simplex to Quadruplex. Plants can be designed with different capacities, physical sizes with a choice of screw, reciprocating and scroll compressors.

- Fully Compliant to HTM 02-01
- Available in a full range of variations
- All interconnecting pipe-work and wiring is supplied
- Fail Safe control system in the event of power loss
- Integral Alarm System Interface indicator
- All plants are tested and certified and are covered by a full warranty



Vacuum Plant

MEC provides a full range of Vacuum plant systems from Simplex to Quadruplex.

- Fully Compliant to HTM 02-01/ HTM 2022
- Available in a full range of variations
- All interconnecting pipework and wiring is supplied
- Fail Safe control system in the event of power loss
- Control panel is fitted with highly visible indicators and gauges
- Integral Alarm System Interface indicator
- All plants are tested and certified and are covered by a full warranty



Manifolds

MEC provides a complete range of manifold systems including Automatic, Emergency Reserve, Emergency Standby and Double Tail Pipe.

- Fully Compliant to HTM 02-01
- Available in a full range of variations
- Supplied with pre-set regulators and pressure sensors
- Highly visible readouts for cylinder content and pipeline pressure
- Both safety relief and isolation valves
- Available for wall mounting or free standing floor mounted variants



A.V.S.U - Area Valve Service unit

- Fully Compliant to HTM 02-01
- Fitted with BS EN 739 NIST connectors
- Fitted with a laser grooved Safe Break window
- Removable door for quick easy access, with reversible door hinges
- Sealed shut off NIST valves
- Standard pipework in 22mm and 28mm
- Each valve is supplied with blanking facility
- Every A.V.S.U is pressure tested with the valves tested for tightness



Lockable Line Valves

All valves are designed for maximum life with requiring minimum maintenance.

- Fully Compliant to HTM 02-01
- Lockable in both open and closed positions
- Pressure tested
- Tested for tightness
- A complete tamper proof locking device can be incorporated
- Solenoid Line Valves Available which are electrically operated and fully comply with HTM 02-01
- NIST Lockable Line Valves, each is supplied with blanking facilities



Zone Service Unit

MEC provides Architectural equipment that is designed for maximum life without compromising on quality as well as being cost effective and requiring minimal maintenance.

- Fully Compliant to HTM 02-01
- Available in Surface and Part recessed format
- Available from one to six gases
- Fitted with BS EN 739 NIST connectors
- Includes all internal pipework and stubbed
- Shire alarm panels fitted and tested, Connections outside of the Enclosure for easy fitting
- Pipework soldered using Inert Gas Jointing
- Pressure Sensors fitted with minimum leak facility
- Other Alarms and colours available

ACCESSORIES AND SPARES

HOSE ACCESSORIES



119201R

Anti-Static Hose 30m Roll PVC

12.3mm od x 6.3mm id

COLOUR	PART No.	PRICE Ea.
White - O2	119201R	£88.00
Black - Air	119202R	£88.00
Black/White - Air	119202BWR	£88.00
Blue - N2O	119203R	£88.00
Yellow - Vacuum	119204R	£88.00
Blue/White - N2O/O2	119207R	£88.00
Grey - CO2	119205R	£88.00
Yellow - Vacuum 8mm ID	119204/8IDR	£99.00

- Manufactured to current European Standard
- Exceptional performance and renowned for reliability
- Reinforced anti-static, low toxic liner
- Cadmium and silicone free
- Resistant to a wide range of chemicals
- Phthalate free
- Anti-Microbial



119202PHR

Anti-Static Hose 30m Roll Polyurethane

12.7mm od x 6.7mm id

COLOUR	PART No.	PRICE Ea.
White - O2	119201PHR	£165.00
Black - Air	119202PHR	£165.00
Blue - N2O	119203PHR	£165.00
Yellow - Vacuum	119204PHR	£165.00
Grey - CO2	119205PHR	£165.00
Blue/White - N2O/O2	119207PHR	£165.00
Brown/White - Heliox	119209PHR	£165.00

- Manufactured to current European Standard
- Does not contain plasticisers in any form
- Will not work harden
- Phthalate free
- Odour free



4131

Ferrule

For Anti-Static Hoses (above)

DESCRIPTION	PART No.	PRICE Ea.
Ferrule	4131	£0.60

- Stainless steel
- Site hole indicator



CS1P

Heat Shrinking Sleeving

25mm Length - Pack 10

COLOUR	PART No.	PRICE Ea.
White	CS1P	£2.75
Black	CS2P	£2.75
Blue	CS3P	£2.75
Yellow	CS4P	£2.75

ACCESSORIES AND SPARES

ORB TERMINAL UNIT SPARES AND ACCESSORIES



202211UK

Upgrade Kits

Front cover and ORB Second Fix

- Upgrades MEC Terminal Units to ORB Smoothflow
- Two part kit easy to fit
- Gas specific sockets with cover plate
- For use with MEC Gas outlets only
- Fully compliant with all current standards



DESCRIPTION	PART No.	PRICE Ea.
O2 ORB Upgrade Kit	202211UK	£22.50
O2/N2O ORB Upgrade Kit	202212UK	£22.50
N2O ORB Upgrade Kit	202213UK	£22.50
Air-7 ORB Upgrade Kit	202214UK	£22.50
Air-4 ORB Upgrade Kit	202215UK	£22.50
Vacuum ORB Upgrade Kit	202216UK	£22.50



2022BP

Terminal Unit Blanking Plug

DESCRIPTION	PART No.	PRICE Ea.
Terminal Unit Blanking Plug	2022BP	£2.00
Air Terminal Unit Blanking Plug	2025BP	£2.00

202216N

ORB Smoothflow Spares

Cartridge Assembly

- For use when servicing MEC outlets only

Second Fix

- Gas specific sockets
- For use with MEC Gas outlets only
- Fully compliant with all current standards

DESCRIPTION	PART No.	PRICE Ea.
ORB Cartridge Assembly	202210	£3.60
ORB Cartridge Assembly + 1st Fix 'O' Ring	202210/S	£3.75
ORB Adaptor Plate 'O' Ring (Pkt 25)	202148P	£3.75
ORB O2 2nd Fix	202211N	£19.95
ORB O2/N2O 2nd Fix	202212N	£19.95
ORB N2O 2nd Fix	202213N	£19.95
ORB Air-7 2nd Fix	202214N	£19.95
ORB Air-4 2nd Fix	202215N	£19.95
ORB Vacuum 2nd Fix	202216N	£19.95
Heliox	202219N	£19.95

202210

Spares (Pre 2017)

Cartridge Assembly

- For use when servicing MEC Medical outlets only

Second Fix

- Gas specific sockets
- For use with MEC Gas outlets only
- Fully compliant with all current standards

DESCRIPTION	PART No.	PRICE Ea.
Cartridge Assembly	202210	£3.60
Cartridge Assembly + 1st Fix 'O' Ring	202210/S	£3.75
Adaptor Plate 'O' Ring (Pkt 25)	202148P	£3.75
Standard O2 2nd Fix	202211	£24.95
Standard O2/N2O 2nd Fix	202212	£24.95
Standard N2O 2nd Fix	202213	£24.95
Standard Air-7 2nd Fix	202214	£24.95
Standard Air-4 2nd Fix	202215	£24.95
Standard Vacuum 2nd Fix	202216	£24.95
AGSS 2nd Fix	231715	£33.75

FLOWMETER ACCESSORIES



601200HA

Flowmeter Adaptor

With 1m Hose Assembly - Railmount

GAS	PART No.	PRICE Ea.
O2 Bracket and Hose Assembly	601200HA	£43.50
Air-4 Bracket and Hose Assembly	601205HA	£43.50

Alternative hose length may be specified at time of order

- 1m coloured gas specific anti-static hose
- British Standard remote probe
- 44mm rail mounting bracket

ACCESSORIES AND SPARES

FLOWMETER ACCESSORIES



60168P

Tubing Nipple 9/16"x18 UNF

QUANTITY	PART No.	PRICE Ea.
Pack 10 White	60168P	£17.50
Pack 10 Black	60168BLP	£17.50

• White or Black Acetal Plastic



116224

Nasal Cannulae With 1.8m Tube

DESCRIPTION	PART No.	PRICE Ea.
Nasal Cannulae inc. 1.8m Tube	116224	£1.95



821130

Humidifiers

DESCRIPTION	PART No.	PRICE Ea.
Disposable	821130	£3.75
Autoclavable	821135	£16.75



116221

Face Mask With 1.8m Tube

DESCRIPTION	PART No.	PRICE Ea.
Adult inc. 1.8m Tube	116221	£1.75
Paediatric inc. 1.8m Tube	116222	£1.75

REGULATOR ACCESSORIES



116102

Combination Spanner

DESCRIPTION	PART No.	PRICE Ea.
Combination Spanner	116102	£7.50

• Enables on/off function on Bullnose Cylinders
• For tightening Bullnose regulators to cylinders



160202-02

O2 Bullnose to Pin Index Cylinder Block

DESCRIPTION	PART No.	PRICE Ea.
O2 Bullnose to Pin Index Cylinder Block	160202-02	£75.00



6057

Pin Index Yoke

Yoke Only

GAS	PART No.	PRICE Ea.
O2	6057	£32.50
Air	6058	£32.50
N2O	6057/3	£32.50
O2/N2O	6057/2	£75.00
CO2	6055	£32.50

ACCESSORIES AND SPARES

REGULATOR ACCESSORIES



185706

Regulator Spares

DESCRIPTION	PART No.	PRICE Ea.
S/Stage Contents Gauge BSP	185706	£19.50
S/Stage Contents Gauge NPT	185706NPT	£19.50
Two Stage Contents Gauge	185715	£20.50
Two Stage 0-16 Bar Gauge	185707	£20.50
Bullnose 'O' Ring (Pack 10)	185703P	£12.50
Bodoc Seal	185705	£0.75



116108

Pin Index Key

DESCRIPTION	PART No.	PRICE Ea.
Pin Index Key	116108	£12.95

• Enables on/off function on Pin Index Cylinders



116112

Bottle Spindle Key

DESCRIPTION	PART No.	PRICE Ea.
Bottle Spindle Key	116112	£12.95



160201-O2

Bullnose/Pin Index Adaptor

Right Angle

GAS	PART No.	PRICE Ea.
O2	160201-O2	£57.75
Air	160201-AIR	£57.75
N2O	160201-N2O	£57.75
O2/N2O	160201-MIX	£115.75
CO2	160201-CO2	£57.75

• To enable use of standard Bullnose regulator on Pin Index cylinder

ACCESSORIES AND SPARES

SUCTION ACCESSORIES

- Autoclavable polysulphone collection jar
- Complete with cap assembly and overflow safety valve



FSP795-110000

Autoclavable Receiver Jar

DESCRIPTION	PART No.	PRICE Ea.
Autoclavable Receiver Jar 1500ml	FSP795-110000	£41.50
Autoclavable Receiver Jar 2000ml	FSP795-120000	£46.50
Autoclavable Receiver Jar 1500ml Mounted on Rail Clamp	FSP795-111200	£50.50
Autoclavable Receiver Jar 2000ml Mounted on Rail Clamp	FSP795-121200	£55.50
Autoclavable Receiver Jar 1500ml Mounted on Male 'V' Wedge	FSP795-111700	£44.50
Autoclavable Receiver Jar 2000ml Mounted on Male 'V' Wedge	FSP795-121700	£48.50



BLH033R

PVC Suction Tubing

30m

DESCRIPTION	PART No.	PRICE Ea.
Suction Tubing Clear 30m	BLH032R	£27.50
Suction Tubing Yellow 30m	BLH033R	£27.50



BLH031

Silicone Tubing

DESCRIPTION	PART No.	PRICE Ea.
Silicone Tubing Per Metre	BLH031	£4.95



ASP980

Disposable Hydrophobic Filter

DESCRIPTION	PART No.	PRICE Ea.
Box of 10 Filters	ASP980	£32.50



BIF001

Disposable Bacterial Filter

DESCRIPTION	PART No.	PRICE Ea.
Box of 10 Filters	BIF001	£37.50

Disposable Hydrophobic Filter

DESCRIPTION	PART No.	PRICE Ea.
Box of 10 Filters	BIF013	£79.50

Electric Foot Switch

Air Operated with Electric on/off Actuator

DESCRIPTION	PART No.	PRICE Ea.
Electric Foot Switch	AES910	£105.00

Heavy Duty Electric Foot Switch

Die-case Metal

DESCRIPTION	PART No.	PRICE Ea.
Heavy Duty Electric Foot Switch	ASE915	£205.50

ACCESSORIES AND SPARES

AMBULANCE PIPELINE ACCESSORIES



116105

'T' Piece

DESCRIPTION	PART No.	PRICE Ea.
'T' Piece	116105	£11.65



116106ST

Straight Hose Connector

DESCRIPTION	PART No.	PRICE Ea.
Straight Hose Connector	116106ST	£6.50



116198P

Fastners and Clips

DESCRIPTION	PART No.	PRICE Ea.
Pipeline Clips (Pk 100)	116198P	£10.00
Self-tapping Screw (Pk 100)	116199P	£5.00

AGSS ACCESSORIES AND SPARES



231746

AGSS Probe Euro Version Type 1L

DESCRIPTION	PART No.	PRICE Ea.
AGSS Probe Type 1L	231746	£19.50

- Stainless Steel body



231740

AGSS Probe Assembly

DESCRIPTION	PART No.	PRICE Ea.
AGSS Probe Assembly 16mm Tail	231740	£18.50
AGSS Probe Assembly 12mm Tail	231740SP	£18.50



231741RA

AGSS 90° Probe Assembly

DESCRIPTION	PART No.	PRICE Ea.
AGSS 90° Probe Assembly	231741RA	£29.95



231742

AGSS Nut

DESCRIPTION	PART No.	PRICE Ea.
AGSS Nut	231742	£6.45



231743

AGSS 'O' Ring

DESCRIPTION	PART No.	PRICE Ea.
AGSS 'O' Ring	231743	£0.20

ACCESSORIES AND SPARES

AGSS ACCESSORIES AND SPARES



202148

Bayonet Probe 'O' Ring

DESCRIPTION	PART No.	PRICE Ea.
Bayonet Probe 'O' Ring	202148	£0.20



231747/8

AGSS Adjusting Tool Set

DESCRIPTION	PART No.	PRICE Ea.
AGSS Adjusting Tool Set (MEC only)	231747/8	£35.00



231713P

AGSS Terminal Unit Blanking Plug

DESCRIPTION	PART No.	PRICE Ea.
AGSS Terminal Unit Blanking Plug	231713P	£14.95



181916R

Clear PVC Braided Hose

30m Roll - (23mm OD x 16mm ID)

DESCRIPTION	PART No.	PRICE Ea.
Clear PVC Braided Hose	181916R	£69.50

- Glass clear clarity for excellent visibility
- Excellent resistance to abrasion
- Manufactured from cadmium and silicone-free materials using a special low toxic, odourless PVC formulation



231735R

Reinforced PVC Hose

50m Roll - (19mm OD x 12.7mm ID)

DESCRIPTION	PART No.	PRICE Ea.
Reinforced PVC Purple Hose	231739R	£119.50

- Superior quality PVC specifically selected for higher working pressures in both low and high temperature environments
- Extremely flexible and durable
- Excellent abrasion, ageing and ultra-violet ray resistance
- Good anti-kink characteristics and minimum flow loss



181934

Transfer Hose Assembly

2.4m

DESCRIPTION	PART No.	PRICE Ea.
Transfer Hose Assembly	181934	£47.50

- Complete with Pressure Relief Valve (PRV)
- 30mm Male Connector



181919

Ferrule

For Clear PVC Braided Hose (above)

DESCRIPTION	PART No.	PRICE Ea.
Ferrule for Clear PVC Hose	181919	£1.25



231734

Ferrule

For Reinforced PVC Purple PVC Hose (above)

DESCRIPTION	PART No.	PRICE Ea.
Ferrule for Purple PVC Hose	231734	£0.85



12800013

Disposal Hose

3m

DESCRIPTION	PART No.	PRICE Ea.
Disposal Hose	12800013	£80.65

- AGSS Probe Assembly
- Top swivel assembly for use with MEC receiving system only

ACCESSORIES AND SPARES

AGSS ACCESSORIES AND SPARES



12800013PR

Disposal Hose - AGSS Probes

3m - (23mm OD x 16mm ID)

DESCRIPTION	PART No.	PRICE Ea.
Disposal Hose	12800013PR	£52.50
Disposal Hose 90°	12800013PRRA	£62.50

• AGSS Probe Assembly at both ends



12800013PRSP

Disposal Hose - AGSS Probes

3m - (19mm OD x 12mm ID)

DESCRIPTION	PART No.	PRICE Ea.
Disposal Hose	12800013PRSP	£52.50
Disposal Hose 90°	12800013PRSPRA	£62.50



RS3P

Heat Shrink

Pack of 10

DESCRIPTION	PART No.	PRICE Ea.
Blue Heat Shrink (Pack 10)	RS3P	£6.00
Yellow Heat Shrink (Pack 10)	RS4P	£6.00



40208

Wall Mounting Bracket

DESCRIPTION	PART No.	PRICE Ea.
Wall Mounting Bracket	40208	£12.50

• V Wedge Mounting Bracket



40207

Rail Mounting Bracket

DESCRIPTION	PART No.	PRICE Ea.
Rail Mounting Bracket	40207	£12.50

• 44mm Standard Universal Rail Bracket



40209

Horizontal Rail Clamp + 'V' Wall Bracket

DESCRIPTION	PART No.	PRICE Ea.
Horizontal Rail Clamp 'V' Wall Bracket	40209	£27.50

• 44mm Standard Universal Rail Bracket
• Complete with 'V' Bracket

ACCESSORIES AND SPARES

AGSS ACCESSORIES AND SPARES



1280060

Pole Clamp with 'V' Bracket

20-38mm Diameter Pole

DESCRIPTION	PART No.	PRICE Ea.
Pole Clamp + 'V' Bracket	1280060	£47.00

- For use with 20-38mm diameter poles
- Complete with 'V' Bracket



181933R

22mm Transfer Hose

50m Roll (Cuffed at 40cm)

DESCRIPTION	PART No.	PRICE Ea.
22mm Transfer Hose	181933R	£54.00



181931

Pressure Relief Valve (PRV)

DESCRIPTION	PART No.	PRICE Ea.
Pressure Relief Valve (PRV)	181931	£33.75

- 30mm Female Connector
- 22mm Male Connector
- 10 cm (1 kPa) H₂O pre-set valve



181932P

30mm Male Conical Connector

Pack of 10

DESCRIPTION	PART No.	PRICE Ea.
30mm Male Conical Connector	181932P	£27.00

- 30mm Male Connector
- 22mm Female Connector



181932FP

30mm Female Conical Connector

Pack of 10

DESCRIPTION	PART No.	PRICE Ea.
30mm Female Conical Connector	181932FP	£27.00

- 30mm Male Connector
- 22mm Male Connector

800450

Limited Life Particle Filter



DESCRIPTION	QUANTITY	PART No.	PRICE Ea.
Limited Life AGSS Particle Filter	Bag 100	800450	£376.50
Limited Life AGSS Particle Filter	Bag 50	800451	£219.50
Limited Life AGSS Particle Filter	Bag 25	800452	£125.50
Filter Hose Connector for above including Ferrules	Pack 2	800460P	£18.50

- 2 week recommended life Anaesthetic Gas Scavenging filters

ACCESSORIES AND SPARES

PURAIR SCAVENGING SYSTEMS ACCESSORIES



132211

Scavenging Nasal Inhaler

Model B

DESCRIPTION	PART No.	PRICE Ea.
Scavenging Nasal Inhaler	132211	£160.00

- Lightweight autoclavable Nasal Hood
- Choice of Adult, Child or Paediatric size (equivalent to Large, Medium and Small)



750048

Drain Trap Hose Assembly

For Purair 750

DESCRIPTION	PART No.	PRICE Ea.
Drain Trap Hose Assembly	750048	£25.00

- Medium self-sealing water trap (70ml)
- 30mm Male Connector
- 30mm Female Connector



750052P

Drain Trap

Pack of 10

DESCRIPTION	PART No.	PRICE Ea.
Drain Trap (Pack 10)	750052P	£36.50

- Medium self-sealing water trap (70ml)



181931

Pressure Relief Valve (PRV)

DESCRIPTION	PART No.	PRICE Ea.
Pressure Relief Valve (PRV)	181931	£33.75

- 30mm Female Connector
- 22mm Male Connector
- 10 cm (1 kPa) H₂O pre-set valve

EMERGENCY KIT ACCESSORIES AND SPARES

EKS2BOXN

Emergency Kit Box



DESCRIPTION	PART No.	PRICE Ea.
Emergency Kit Box	EKS2BOXN	£300.00

ACCESSORIES AND SPARES

EMERGENCY KIT ACCESSORIES AND SPARES



EKH1

Pendant Hose

300mm

GAS	PART No.	PRICE Ea.
O2	EKH1	£116.50
Air-4	EKH1A	£116.50
Air-7	EKH1A7	£116.50
O2/N2O	EKH1MIX	£116.50
N2O	EKH1N2O	£116.50

- 300mm coloured gas specific anti-static hose
- British Standard NIST Nut + NIST Probe assembly
- British Standard gas specific pendant head
- (MRI version available, not as standard)



EKH3MIX

Splitter Hose

3m

GAS	PART No.	PRICE Ea.
O2	EKH3	£37.75
Air-4	EKH3A	£37.75
Air-7	EKH3A7	£37.75
O2/N2O	EKH3MIX	£37.75
N2O	EKH3N2O	£37.75

- 3m coloured gas specific anti-static hose
- British Standard remote probes
- MRI compatible



185705

Bodoc Seal

DESCRIPTION	PART No.	PRICE Ea.
Bodoc Seal	185705	£0.75

TEST EQUIPMENT ACCESSORIES AND SPARES

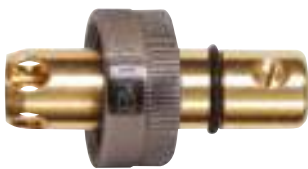

19031120

Set of 5 AGSS Test and Commissioning Probes

DESCRIPTION	PART No.	PRICE Ea.
AGSS Test and Commissioning Probes	19031120	£155.00



20011

Particulate Filters (Box of 25)

DESCRIPTION	PART No.	PRICE Ea.
Particulate Filters (Box of 25)	20011	£85.00



DEWP3

Universal Probe

With 6mm Connector

DESCRIPTION	PART No.	PRICE Ea.
Universal Probe with 6mm Connector	DEWP3	£99.00

DEWP1

Particulate Filter Cartridges

(Pack of 10) For Easidew Portable Hygrometer

DESCRIPTION	PART No.	PRICE Ea.
Particulate Filters (Pack of 10)	DEWP1	£85.00

ACCESSORIES AND SPARES

TEST EQUIPMENT ACCESSORIES AND SPARES



00714

Universal Probe

With 1/4" BSP

DESCRIPTION	PART No.	PRICE Ea.
Universal Probe with 1/4" BSP	00714	£55.50



20097

NIST Test Probes

GAS	PART No.	PRICE Ea.
Nitrogen	20097	£39.95
CO2	20098	£39.95
O2/HeliOX [He ≤ 80% (Volume Fraction)]	20099	£39.95



23020

Orifice

2KPA

DESCRIPTION	PART No.	PRICE Ea.
Orifice 2KPA	23020	£75.00

· To Upgrade Pre-2011 232005 Test Set to meet HTM02-01 and relevant European Standards and all preceding standards



20081

Spares for 2005N Test Set

DESCRIPTION	PART No.	PRICE Ea.
O2 Probe	20081	£29.95
O2/N2O Probe	20082	£29.95
N2O Probe	20083	£29.95
Air-7 Probe	20084	£29.95
Air-4 Probe	20085	£29.95
Vacuum Probe	20086	£29.95
NO Probe	20087	£34.95
HeliOX Probe	20089	£34.95
Pressure Gauge	20054	£25.00
Vacuum Gauge	205602	£25.00
Storm Test Set Box	20056D	£350.00



53100038TSP

DIN Test Probes

(German Standard)

GAS	PART No.	PRICE Ea.
O2	53100038TSP	£125.00
N2O	53100039TSP	£125.00
Air ('D' Shape)	53100040TSP	£125.00
Vacuum	53100041TSP	£125.00
Compressed Air (Square)	53100042TSP	£125.00
CO2	53100043TSP	£125.00



MEC Medical Ltd | Unit 3, Trust Industrial Estate, Wilbury Way, Hitchin, Hertfordshire, SG4 0UZ, United Kingdom

 +44 (0) 1462 436 396 sales@mecmedical.com www.mecmedical.com